

# Wanamero of the Mins! Joyd



*In honor of my parents Marian and Howard Johnson and  
my brother David Johnson*

# ***Introducing Nameofthelord777 Ministry Short History and Focus***

Short History of our Ministry we are non denominational Self funded Ministry. We started in 2013 January with two branches one in Mandaue Cebu and now others in Palawan Philippines. Because of the Deceptions of the Last Days Revealed as he promised in these last Days like no Third Temple, Last Trump , Babylon is Fallen Fallen, and the Flat Earth we have chosen to consolidate our emphasis into two Ministries one reaching Philippines and the USA via Internet(God revealed the Flat earth in late 2016). Second we still have 144 active Ministry with thousands of others receiving sandals as a gift emphasizing God's love for them. of on two Islands from 3 years to 90 years of age. (Three Ministries in Palawan are soon to be revived as the Latter Rain is coming.) We Seek to reach the Lost and edify the Saved through the PROMOTION OF BIBLE TEACHING RELEVANT TO THE LAST DAYS i.e. BIBLE READING/TEACHING AND SCRIPTURE MEMORIZATION. We also have Many You Tube's and PowerPoint studies of Various Topics Relevant to the Bible and Christian Living and of course the End Times or Last Days. Our Emphasis is to prepare and alert the World's Christians to the imminent danger in our perilous End Times and the fact that all signs point to Tribulation and at its end the Rapture and Coming Kingdom of God on Earth known as the Millennium. Nameofthelord777 Ministry can be contacted in Philippines by our

**Main Web Page at [TheLastTrump777.wordpress.com](http://TheLastTrump777.wordpress.com)  
and [FlatEarthandTheLastDaysBlog.wordpress.com](http://FlatEarthandTheLastDaysBlog.wordpress.com)**



**Genesis 1:6 And God said, Let there be a firmament in the midst of the waters, and let it divide the waters from the waters. 7 And God made the firmament, and divided the waters which were under the firmament from the waters which were above the firmament: and it was so. The Globe is one of the greatest Deceptions ever tried by Satan. (What are you believing and why Try a taste of the truth it will be bitter in your mouth than turn to honey in your heart!!!)**



**Our Last Days, Jesus Return is Imminent, Flat Earth Family.  
Left to Right: Joy, Achiah, Grace and Mark**





Isaiah 19:19 In that day shall there be an altar to the LORD in the midst of the land of Egypt, and a pillar at the border thereof to the LORD. (Giza Pyramid)  
20 And it shall be for a sign and for a witness unto the LORD of hosts in the land of Egypt: for they shall cry unto the LORD because of the oppressors, and he shall send them a saviour, and a great one, and he shall deliver them. (See our Future studies for connection to the Last Days 2011-2019) If Mason's leave alone you can find us as This will show the "Design Boss for the Giza Pyramid" in Feet, Sacred Cubits, Royal Cubits and ALL NEW FLAT EARTH DESIGN MILES?

**“The World is Decaying from seemingly Harmless Wizard of OZ Promoting Witches to the latest Obamanation of Transgender Bathrooms and an Altar to Baal was built in London and almost in New York City. Finally the USA Olympic Gymnasts have to wear a Uniform honoring Baphomet! Prepare for Holocaust type persecution ”**

Your almost Late and your Future awaits are you on the road to Destruction of Eternal Life???





*Matt. 24:10 And then shall many be offended, and shall betray one another, and shall hate one another. 11 And many false prophets shall rise, and shall deceive many. 12 And because iniquity shall abound, the love of many shall wax cold.*

**Baphomet is Not only in Detroit he is in the Olympic Uniforms! When will America see its Destiny of Destruction and Christians REPENT. Washington DC is on the 77 Parallel. 77= False Prophet/Mystery Babylon???**



Baphomet statue came on July 25, 2015 to USA it is everywhere integrated into our culture even the Olympic Uniforms...

**Baphomet is everywhere Leave the Worlds System and come Back to the Plan of God's Salvation. His Desire is that None are lost!!!**



*Matt. 24:10 And then shall many be offended, and shall betray one another, and shall hate one another. 11 And many false prophets shall rise, and shall deceive many. 12 And because iniquity shall abound, the love of many shall wax cold.*

**Revealed from God August 11, 2017 .Vive LasVegas Key in Kingsman Movie confirms our Sept. 30,2017. Las Vegas Shooting of a gunman MK Ultra controlled with 23 Guns(Death and punishment) and 33= ties to Masons and the size of the Sun. Wake up**



**Founding of America  
July 4, 1776**



**Decline of America  
July 4, 2017**



**Day of Atonement –  
Sept. 30, 2017**



**Decoded Shooting in Las Vegas Predicted on August 11, 2017**





**Revival = Latter Rain has started in the World!!!**

**NEW**  
**One of the two Last Days witnesses: Read the Harbinger and now the Paradigm Better Yet accept Jesus as Your personal Savior!!!**

# **Jonathan Cahn Prophecy (July 4, 2018)**





*Matt. 24:10 And then shall many be offended, and shall betray one another, and shall hate one another. 11 And many false prophets shall rise, and shall deceive many. 12 And because iniquity shall abound, the love of many shall wax cold.*

**Baphomet is Not only in Detroit he is in the Olympic Uniforms! When will America see its Destiny of Destruction and Christians REPENT. Washington DC is on the 77 Parallel. 77= False Prophet/Mystery Babylon???(aligned with Mecca)**

The Nazis were not killed and Defeated in WW2 they moved to America to Head Nasa and all other Organizations ie Mason's. Washington DC is on the 77<sup>th</sup> Longitude. In Biblical Numerology 77=False Prophet. It is Clear as the Bible Says Mystery Babylon will be THE World Leader of Military and Sin. (55 Million Abortions and the Leader in exporting Pornography to the World. ie 70-80%. ) If your pride has blinded you as Matt. 24:10-12 says it will you better get ready for Chaos. Hillary has just killed 6 people in the last 6 weeks and CNN has said nothing. When they come for you if you smell like a Christian you will cry and no one will come. Your Only Hope is Trust in Jesus of the BIBLE. God has raised up enemies to Bring you down since you have not decided to Pray and Repent. ie ISIS created by Obama(Antichrist Forerunner), Russia (Magog), and Iran (Persian Empire). May



**The more we do to you, the less you seem to believe we are doing it.**

**- Joseph Mengele**





*Matt. 24:10 And then shall many be offended, and shall betray one another, and shall hate one another. 11 And many false prophets shall rise, and shall deceive many. 12 And because iniquity shall abound, the love of many shall wax cold.*

## *Rev. 13 Sea / Earth Beast-The Catholic Church-Rome-Vatican*

**Sea Beast is the Vatican Killed Millions of Christians from 538 AD until Silenced in 1798. However the Resurrection is Complete as it was Reestablished in 1929 Lateran treaty!**



# FIRST BEAST



**Earth Beast is Pope Francis Elected on March 13, 2013. His Purpose is to Bring ABOUT THE TOTAL WORSHIP OF THE FIRST BEAST. That Starts with the Abomination of Desecration which will Occur on September 28, 2015.**

# SECOND BEAST

**Caution!!!**  
Advanced Studies  
follow the order or  
risk getting prideful  
and turning back to  
the world for  
wisdom>>>

## 1. OphirisPhilippines.com

Return of Jesus foretold clearly in the Giza Pyramid Our Premier site Honoring the King of Kings and his Return!!! Special Bonus Links to The Latest Revelations of "The God Culture and the Location of Eden, Ophir, Havilah, and Sheba all in the PHILIPPINES!!!

## 2. Thelasttrump777.wordpress.com

Last Days info with a bit of everything and Archived Studies

## 3. Godslastdayswisdome.com

Matt. Chap. 24 the Blue Print of the Last days in Jesus own words!

## 4. Flatearthandthelastdaysblog.wordpress.com

Author's Design of God's Flat Earth

## 5. Nameofthelord777.wordpress.com

Basic Ministry and Biblical Foundational Studies

## 6. Trumpputinerdoganobamaantichrist.com

Know Satan the Antichrist and his Deceptions

## 7. Future Effort

Not revealed to the Author at this time... stay informed and keep looking up your redemption draweth nigh!!!



Nameofthelord777 Ministry  
Promising to tell the Greatest Story  
Ever of Jesus Return in these Last  
Days, as long as I have Breathe!!!

*OCC – Oasis of Christ's Children  
2013-Millennium*

**Revival = Latter Rain has started in the World!!!**

**NEW**  
**One of the two Last Days witnesses: Read the Harbinger and now the Paradigm Better Yet accept Jesus as Your personal Savior!!!**

# **Jonathan Cahn Prophecy (July 4, 2018)**





# 14 Year Last Days Timing 2010-2024



**July 26, 2018**  
The 9<sup>th</sup> Blood Moon of the 9<sup>th</sup> tetrad.  
**Speed of the Sun** = 880 mph = BNM is Fortresses of Bastards Fall / Righteous Afflicted

**Feb. 20, 2018**  
11<sup>th</sup> month 24<sup>th</sup> day  
Loosing of the 4 Carpenters to rebuild Jerusalem.  
**Speed of the Moon** = 861 mph = BNM is Anti-Christ Comes

**Jan. 31, 2018**  
the 8<sup>th</sup> Blood Moon of the 9<sup>th</sup> final and perfect tetrad.  
**Speed of the Sun** = 1175 mph = BNM is Trumpets Sound the End is Here.

**Sept. 27, 2024**  
Day of Atonement : Jesus and his great Multitude and the battle of Armageddon.  
**Speed of the Moon** = 862mph = BNM is The Great Tribulation (End)

**Oct. 3, 2024**  
Feast of tabernacles; Jesus fellowship with Men in Jerusalem.  
**Speed of the Sun** = 1077 mph = BNM is Where O Death is Your Sting? / Fire from Heaven.

**Sept. 15, 2024**  
feast of Trumpets Start of Jesus returning.  
**Speed of the Sun** = 1025 mph = BNM is If you See an Angel Leave the City.

**Dec.11, 2017**  
Two Witnesses Start 42 Months of ministry will finish on May 24/27, 2021.  
**Speed of the Sun** = 1272 mph = BNM is Love Wisdome

**Aug. 16, 2024**  
Dan 9:24-27 1260 days complete.  
**Speed of the Sun** = 940 mph = BNM is Cities that Spurn the Prophet Go to Hell.

**Feb. 4, 2023**  
Antichrist is Thrown in the Lake of Fire after 1260 days reigning  
**Speed of the sun** is 1162.6 mph and 1011 NMPH.  
BNM=1163=SPIRIT OF ANTICHRIST IN THE WORLD

**Nov. 9, 2017**  
Trump starts his 378 days in Noah's Timeframe and **Nov. 16** day of Alice in Wonderland tweet. He will come out on Nov.22,2018.  
**Speed of the Sun** = 1164 mph = BNM is Beast of the Earth Eats the Flesh of his Harlot / The Beast

**Dec. 6, 2017**  
Leeland Teaches Cyrus Decree fulfilled by Trump Embassy Move of USA to Jerusalem.  
**Speed of the Sun** = 1258 mph = BNM is Depart Love of the Lord; Dead on Arrival.

**Nov. 11, 2021**  
Abom. That Makes Desolate. The Sophia Robot that talks is setup on the temple (Dan.12:11)  
**Speed of the sun** = 1187 mph = BNM is Satan Chained; Millennium Kingdom of God / City Burns; New Covenant

**March 5, 2021**  
End of the trumpets and the start of the Bowls.  
**Speed of the Sun** = 1180 mph = BNM is Killed by the Sword, Taken Captive by the Beast / High Priest Abandons the Flock.

**Sept. 23, 2015**  
Pope Francis False Prophet appears in America.  
**Speed of the Sun** in Nautical Miles is 911nmph. BNMs is Man's Glory is Nothing / Man's Leadership

**Sept. 22-23, 2017** - Sun Glad Woman sign 9-22 Start of Tribulation.  
**Speed of the Sun** 911 nmph = BNM is Man's Glory is Nothing / Man's Leadership

**Mar. 13, 2019**  
End of Loosing of the 4 Carpenters.  
**Speed of the Sun** = 1155 mph = BNM is Rejoice: You Participate in Sufferings of Christ /

**Aug. 24, 2019**  
The Antichrist and Latter Rain and WW3 Starts his Reign  
**Speed of the Sun** = 962 mph = Height of Cixa since 28 BNM SERVANTS OF SATAN IN GREAT FEAR BEFORE GOD. Angle of Sun = 49 = BNM=Time of end.

**Aug.20, 2017**  
Great American Eclipse is Leeland's timing of the end of the 1<sup>st</sup> 7 years of Ahasuerus. Start of Bad years.  
**Speed of the Moon** = 809 mph = BNM is Table of Money-lenders Over-turned.

**July 25, 2015**  
Baphomet is in Detroit symbolizes the Obama. Dan. 7:8 Little Horn birth  
**Speed of the Sun** = 877 mph = BNM is Man's Possessions Devoured.

**Joseph 7 Good Years**

**Jan. 21, 2019**  
Final Blood Moon and end Joseph Good years.  
**Speed of the moon** = 1020 mph = BNM is Testimony of Jesus Gathers the Believers / Holy Communion

**April 30, 2018**  
Date Leeland says the Daily Sacrifice is taken Away.  
**Speed of the sun in nautical miles** = 801 nmph = BNM is, Without God Holy Angels Fall Down

**Sept. 11, 2001**  
The Beginning of the Great Falling Away i.e. 2 Thess. 2:3 or Isa 9:10,11  
**Speed of the Moon** = 1039nmph = BNM is The Great Falling Away

**Nov. 22, 2018**  
Trump's Noah timeframe end he comes out of the Boat.  
**Speed of the moon** = 1037 mph = BNM is Duped Disciples Hear Truth of Jesus / King of Jews; Messiah

**Beginning of Sorrows**



Luke 8:17 For nothing is secret, that shall not be made manifest; neither any thing hid, that shall not be known and come abroad.

# Enoch's Last Days Calendar rediscovered in Qumran in John the Baptist /Essene Caves in 1947 by a Bedouin Shepard

## CREATION CALENDAR

4 <sup>th</sup> Gate 7-Nisan		5 <sup>th</sup> Gate 8-Iyyar		6 <sup>th</sup> Gate 9-Sivan		6 <sup>th</sup> Gate 10-Tammuz		5 <sup>th</sup> Gate 11-Av		4 <sup>th</sup> Gate 12-Elu		3 <sup>rd</sup> Gate 1-Tishrei		2 <sup>nd</sup> Gate 2-Cheshvan		1 <sup>st</sup> Gate 3-Kislev		1 <sup>st</sup> Gate 4-Tevet		2 <sup>nd</sup> Gate 5-Shevat		3 <sup>rd</sup> Gate 6-Adar			
3/21		4/20		5/20		6/20		7/20		8/19		Yom Teruah 9/19		10/19		11/18		12/19		1/18		2/17			
YOM		YOM		YOM		YOM		YOM		YOM		YOM		YOM		YOM		YOM		YOM		YOM		YOM	
2	22	2 Shab	21	2	21	2	21	2 Shab	21	2	20	2	20	2 Shab	20	2	19	2	20	2 Shab	19	2	18		
3	23	3	22	3	22	3	22	3 Wine	22	3	21	3	21	3	21	3	20	3	21	3	20	3	19		
4 Shab	24	4	23	4	23	4 Shab	23	4	23	4	22	4 Shab	22	4	22	4	21	4 Shab	22	4	21	4	20		
5	25	5	24	5	24	5	24	5	24	5	23	5	23	5	23	5	22	5	23	5	22	5	21		
6	26	6	25	6	25	6	25	6	25	6	24	6	24	6	24	6	23	6	24	6	23	6	22		
7	27	7	26	7 Shab	26	7	26	7	26	7 Shab	25	7	25	7	25	7 Shab	24	7	25	7	24	7 Shab	23		
8	28	8	27	8	27	8	27	8	27	8	26	8	26	8	26	8	25	8	26	8	25	8	24		
9	29	9 Shab	28	9	28	9	28	9 Shab	28	9	27	9Atone	27	9 Shab	27	9	26	9	27	9	27	9 Shab	26		
10	30	10	29	10	29	10	29	10	29	10	28	10	28	10	28	10	27	10	28	10	27	10	26		
11Shab	31	11	30	11	30	11Shab	30	11	30	11	29	11Shab	29	11	29	11	28	11Shab	29	11	28	11	27		
12	Apr	12	May	12	31	12	Jul	12	31	12	30	12	30	12	30	12	29	12	30	12	29	12	28		
13	2	13	2	13	Jun	13	2	13	Aug	13	31	13	31	13	31	13	30	13	31	13	30	13	Mar		
14 Pas	3	14	3	14Shab	2	14	3	14	2	14Shab	Sep	14	2	14	Nov	14Shab	Dec	14	Jan	14	31	14Shab	2		
15 ULB	4	15	4	15Shab	3	15	4	15	3	15	2	15 Sub	3	15	2	15	2	15	2	15	2	15	3		
16	5	16Shab	5	16	4	16	5	16Shab	4	16	3	16	4	16Shab	3	16	3	16	3	16	3	16	4		
17	6	17	6	17	5	17	6	17	5	17	4	17	5	17	4	17	4	17	4	17	4	17	5		
18Shab	7	18	7	18	6	18Shab	7	18	6	18	5	18Shab	6	18	5	18	5	18	5	18	5	18	6		
19	8	19	8	19	7	19	8	19	7	19	6	19	7	19	6	19	6	19	6	19	6	19	7		
20	9	20	9	20	8	20	9	20	8	20	7	20	8	20	7	20	7	20	7	20	7	20	8		
21	10	21	10	21Shab	9	21	10	21	9	21Shab	8	21	9	21	8	21Shab	8	21	8	21	7	21Shab	9		
22	11	22	11	22	10	22	11	22	10	22	9	22	10	22	9	22	9	22	9	22	9	22	10		
23	12	23Shab	12	23	11	23	12	23Shab	11	23	10	23	11	23Shab	10	23	10	23	10	23	10	23Shab	11		
24	13	24	13	24	12	24	13	24	12	24	11	24	12	24	11	24	11	24	11	24	11	24	12		
25Shab	14	25	14	25	13	25Shab	14	25	13	25	12	25Shab	13	25	12	25	12	25	12	25	12	25	13		
26 F.F.	15	26	15	26	14	26	15	26	14	26	13	26	14	26	13	26	13	26	13	26	13	26	14		
27	16	27	16	27	15	27	16	27	15	27	14	27	15	27	14	27	14	27	14	27	14	27	15		
28	17	28	17	28Shab	16	28	17	28	16	28Shab	15	28	16	28	15	28Shab	15	28	15	28	15	28	16		
29	18	29	18	29	17	29	18	29	17	29	16	29	17	29	16	29	16	29	16	29	16	29	17		
30	19	30Shab	19	30	18	30	19	30Shab	18	30	17	30	18	30Shab	17	30	17	30	17	30	17	30	18		
				31	19					31	18					31	18					31	19		

Three Principle Gates  
Enoch 75:6-8

Season Leader  
Jun 19  
Hot Winds

Season Leader  
Sep 18  
Grateful  
odour, dew,  
rain, health,  
and life

Season Leader  
Dec 18  
Dew, rain,  
blight, and  
destruction

71:9 In the same  
manner it goes  
forth in the first  
month by the  
GREAT GATE.

THE GREAT  
GATE  
SHUVAH  
HA'SHANAH  
March 20





Luke 8:17 For nothing is secret, that shall not be made manifest; neither any thing hid, that shall not be known and come abroad.

# I'am I'am and the deceiver is NOT I'AM

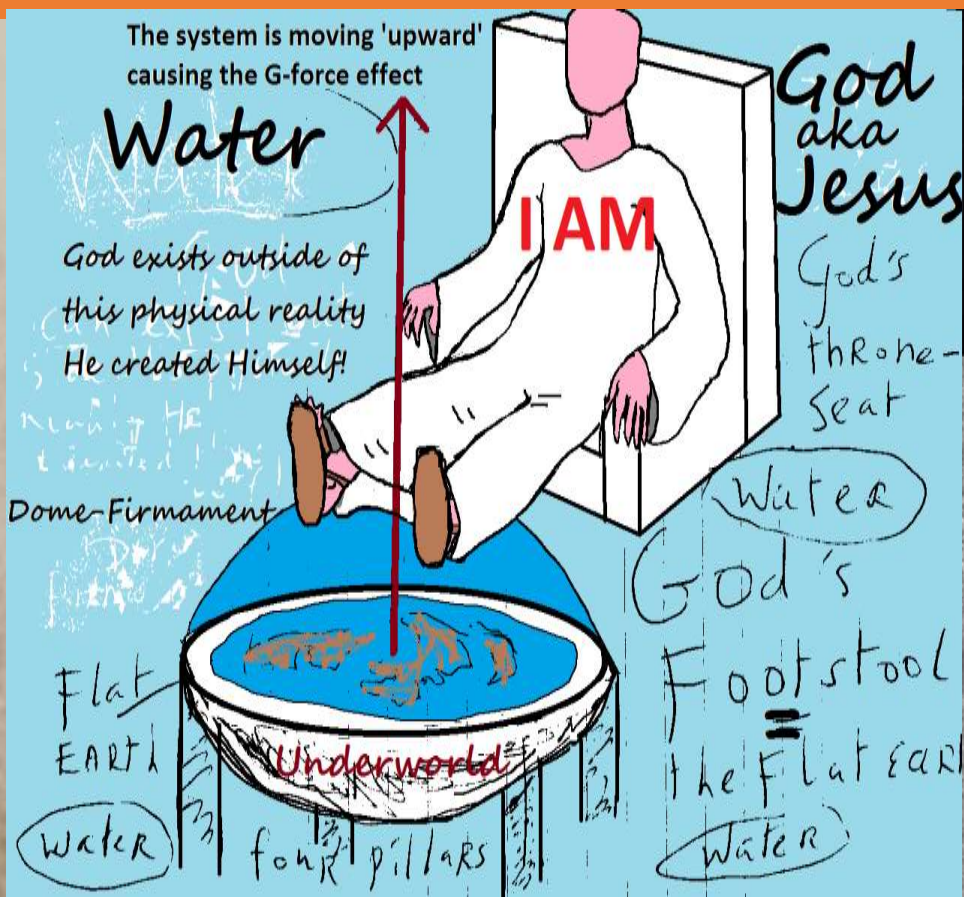

## THE BLACK CUBE OF SATURN



AUSTRALIA



DENMARK



MANHATTAN



SANTA ANA

GLOBAL OCCULT WORSHIP



Luke 8:17 For nothing is secret, that shall not be made manifest; neither any thing hid, that shall not be known and come abroad.

During the Loosing of the 4 Carpenters (God is killing off some of his most ardent enemies!!!)

**"It's easier to fool people than to convince them they have been fooled"**

**-Mark Twain**

Mark Twain a mason, speaks the truth. It is easier to fool the people than convince them they have been fooled!!!





**God's Flat Earth: Everything Comes from Giza Gods witness and testimony. Isa 19,20**

**Great White throne of Judgment=Rev. 20:11**

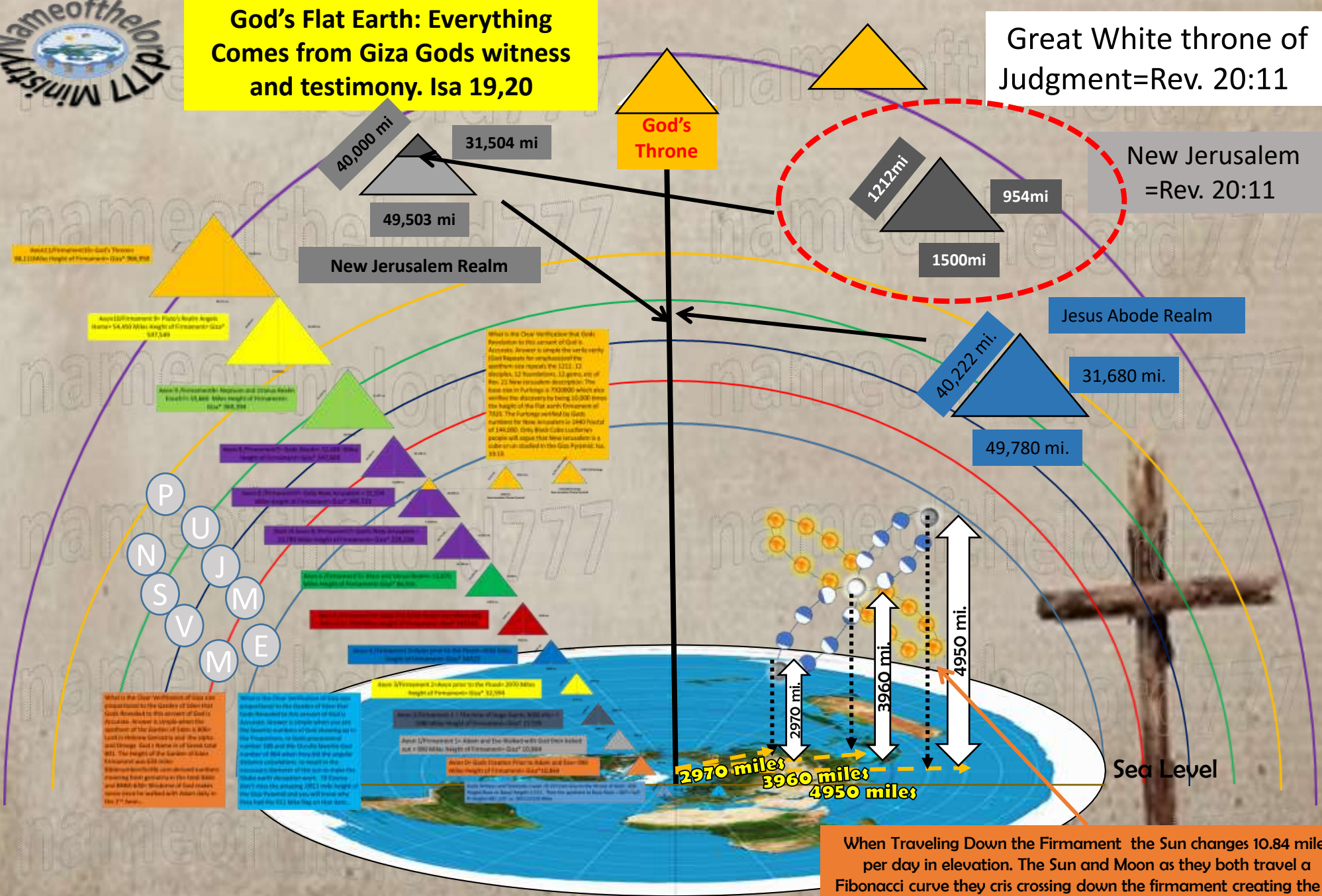

**New Jerusalem =Rev. 20:11**

**Jesus Abode Realm**

**Sea Level**

Level 1 Firmament (to God's Throne) 38,112 Miles Height of Firmament (Isa 66:1) 38,112

Level 2 Firmament (to God's Throne) 34,400 Miles Height of Firmament (Isa 66:1) 34,400

Level 3 Firmament (to God's Throne) 30,688 Miles Height of Firmament (Isa 66:1) 30,688

Level 4 Firmament (to God's Throne) 26,976 Miles Height of Firmament (Isa 66:1) 26,976

Level 5 Firmament (to God's Throne) 23,264 Miles Height of Firmament (Isa 66:1) 23,264

Level 6 Firmament (to God's Throne) 19,552 Miles Height of Firmament (Isa 66:1) 19,552

Level 7 Firmament (to God's Throne) 15,840 Miles Height of Firmament (Isa 66:1) 15,840

Level 8 Firmament (to God's Throne) 12,128 Miles Height of Firmament (Isa 66:1) 12,128

Level 9 Firmament (to God's Throne) 8,416 Miles Height of Firmament (Isa 66:1) 8,416

Level 10 Firmament (to God's Throne) 4,704 Miles Height of Firmament (Isa 66:1) 4,704

Level 11 Firmament (to God's Throne) 1,092 Miles Height of Firmament (Isa 66:1) 1,092

**2970 miles**

**3960 miles**

**4950 miles**

When Traveling Down the Firmament the Sun changes 10.84 miles per day in elevation. The Sun and Moon as they both travel a Fibonacci curve they criss crossing down the firmament creating the 14 phases of the moon. The Moon changes elevation per day by 67.05 miles a day and stays at 45 ° to the Flat Earth North Pole.

P  
U  
J  
M  
S  
V  
M  
E

What is the Clear Verification that God Revealed to His Servant of God's Accidents? Answer is simple the very first (Isa) Reports for unexplained the confirmation via reports the 1212, 12 disciples, 12 Resurrections, 12 graves, etc of Rev. 22 New Jerusalem description. The base one in Fulberg's 700000 which also confirm the discovery to being 10,000 times the height of the Flat Earth Firmament of 2012. The Fulberg worked the base numbers for New Jerusalem to 1040 (Total of 144,000). Only Black-Cube Luciferian people will agree that New Jerusalem is a cube or is situated in the Giza Pyramid. Isa. 23:15.

What is the Clear Verification of God's plan revealed to His Servant of God's Accidents? Answer is simple the very first (Isa) Reports for unexplained the confirmation via reports the 1212, 12 disciples, 12 Resurrections, 12 graves, etc of Rev. 22 New Jerusalem description. The base one in Fulberg's 700000 which also confirm the discovery to being 10,000 times the height of the Flat Earth Firmament of 2012. The Fulberg worked the base numbers for New Jerusalem to 1040 (Total of 144,000). Only Black-Cube Luciferian people will agree that New Jerusalem is a cube or is situated in the Giza Pyramid. Isa. 23:15.

What is the Clear Verification of God's plan revealed to His Servant of God's Accidents? Answer is simple the very first (Isa) Reports for unexplained the confirmation via reports the 1212, 12 disciples, 12 Resurrections, 12 graves, etc of Rev. 22 New Jerusalem description. The base one in Fulberg's 700000 which also confirm the discovery to being 10,000 times the height of the Flat Earth Firmament of 2012. The Fulberg worked the base numbers for New Jerusalem to 1040 (Total of 144,000). Only Black-Cube Luciferian people will agree that New Jerusalem is a cube or is situated in the Giza Pyramid. Isa. 23:15.

What is the Clear Verification of God's plan revealed to His Servant of God's Accidents? Answer is simple the very first (Isa) Reports for unexplained the confirmation via reports the 1212, 12 disciples, 12 Resurrections, 12 graves, etc of Rev. 22 New Jerusalem description. The base one in Fulberg's 700000 which also confirm the discovery to being 10,000 times the height of the Flat Earth Firmament of 2012. The Fulberg worked the base numbers for New Jerusalem to 1040 (Total of 144,000). Only Black-Cube Luciferian people will agree that New Jerusalem is a cube or is situated in the Giza Pyramid. Isa. 23:15.

What is the Clear Verification of God's plan revealed to His Servant of God's Accidents? Answer is simple the very first (Isa) Reports for unexplained the confirmation via reports the 1212, 12 disciples, 12 Resurrections, 12 graves, etc of Rev. 22 New Jerusalem description. The base one in Fulberg's 700000 which also confirm the discovery to being 10,000 times the height of the Flat Earth Firmament of 2012. The Fulberg worked the base numbers for New Jerusalem to 1040 (Total of 144,000). Only Black-Cube Luciferian people will agree that New Jerusalem is a cube or is situated in the Giza Pyramid. Isa. 23:15.

What is the Clear Verification of God's plan revealed to His Servant of God's Accidents? Answer is simple the very first (Isa) Reports for unexplained the confirmation via reports the 1212, 12 disciples, 12 Resurrections, 12 graves, etc of Rev. 22 New Jerusalem description. The base one in Fulberg's 700000 which also confirm the discovery to being 10,000 times the height of the Flat Earth Firmament of 2012. The Fulberg worked the base numbers for New Jerusalem to 1040 (Total of 144,000). Only Black-Cube Luciferian people will agree that New Jerusalem is a cube or is situated in the Giza Pyramid. Isa. 23:15.

What is the Clear Verification of God's plan revealed to His Servant of God's Accidents? Answer is simple the very first (Isa) Reports for unexplained the confirmation via reports the 1212, 12 disciples, 12 Resurrections, 12 graves, etc of Rev. 22 New Jerusalem description. The base one in Fulberg's 700000 which also confirm the discovery to being 10,000 times the height of the Flat Earth Firmament of 2012. The Fulberg worked the base numbers for New Jerusalem to 1040 (Total of 144,000). Only Black-Cube Luciferian people will agree that New Jerusalem is a cube or is situated in the Giza Pyramid. Isa. 23:15.

What is the Clear Verification of God's plan revealed to His Servant of God's Accidents? Answer is simple the very first (Isa) Reports for unexplained the confirmation via reports the 1212, 12 disciples, 12 Resurrections, 12 graves, etc of Rev. 22 New Jerusalem description. The base one in Fulberg's 700000 which also confirm the discovery to being 10,000 times the height of the Flat Earth Firmament of 2012. The Fulberg worked the base numbers for New Jerusalem to 1040 (Total of 144,000). Only Black-Cube Luciferian people will agree that New Jerusalem is a cube or is situated in the Giza Pyramid. Isa. 23:15.

What is the Clear Verification of God's plan revealed to His Servant of God's Accidents? Answer is simple the very first (Isa) Reports for unexplained the confirmation via reports the 1212, 12 disciples, 12 Resurrections, 12 graves, etc of Rev. 22 New Jerusalem description. The base one in Fulberg's 700000 which also confirm the discovery to being 10,000 times the height of the Flat Earth Firmament of 2012. The Fulberg worked the base numbers for New Jerusalem to 1040 (Total of 144,000). Only Black-Cube Luciferian people will agree that New Jerusalem is a cube or is situated in the Giza Pyramid. Isa. 23:15.

What is the Clear Verification of God's plan revealed to His Servant of God's Accidents? Answer is simple the very first (Isa) Reports for unexplained the confirmation via reports the 1212, 12 disciples, 12 Resurrections, 12 graves, etc of Rev. 22 New Jerusalem description. The base one in Fulberg's 700000 which also confirm the discovery to being 10,000 times the height of the Flat Earth Firmament of 2012. The Fulberg worked the base numbers for New Jerusalem to 1040 (Total of 144,000). Only Black-Cube Luciferian people will agree that New Jerusalem is a cube or is situated in the Giza Pyramid. Isa. 23:15.

Teaching the keys to the heights and distances of the Sun and the Moon from Sea Level and the North Pole.



God's Throne = 88022 mi. above the NP = Great White Throne of Judgment Rev. 20:11

Jesus Abode = 31,680 mi.

New Jerusalem = 31,504 mi. = Rev. 21:2

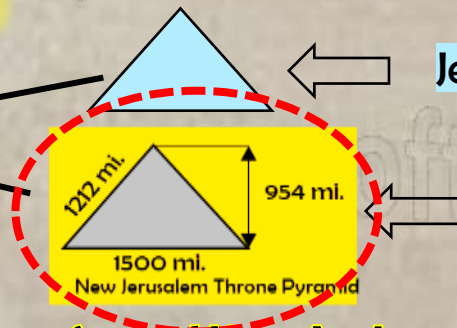

Sun and Moon Analemma = Aleph and Tav = Name of the Lord

*Sun and Moon Horizontal Speeds moving in the firmament*

- ☐ 778 mph at the Tropic of Cancer (BNM=Good News)
- ☐ 1037 mph at the Equator (BNM=Falling Away)
- ☐ 1296 mph at the Tropic of Capricorn (BNM= New Jerusalem)

10<sup>th</sup> Firmament = God's Throne = 88,022 mi. (88022 Trump text)

9<sup>th</sup> = 54,450 mi. Pluto & Angels

8<sup>th</sup> = 33,660 mi. Neptune & Uranus

7<sup>th</sup> = 20,790 mi. Saturn & Jupiter Jesus & NJ

6<sup>th</sup> = 12,870 mi. Venus & Mars

5<sup>th</sup> = 7920 mi. Mercury & Earth

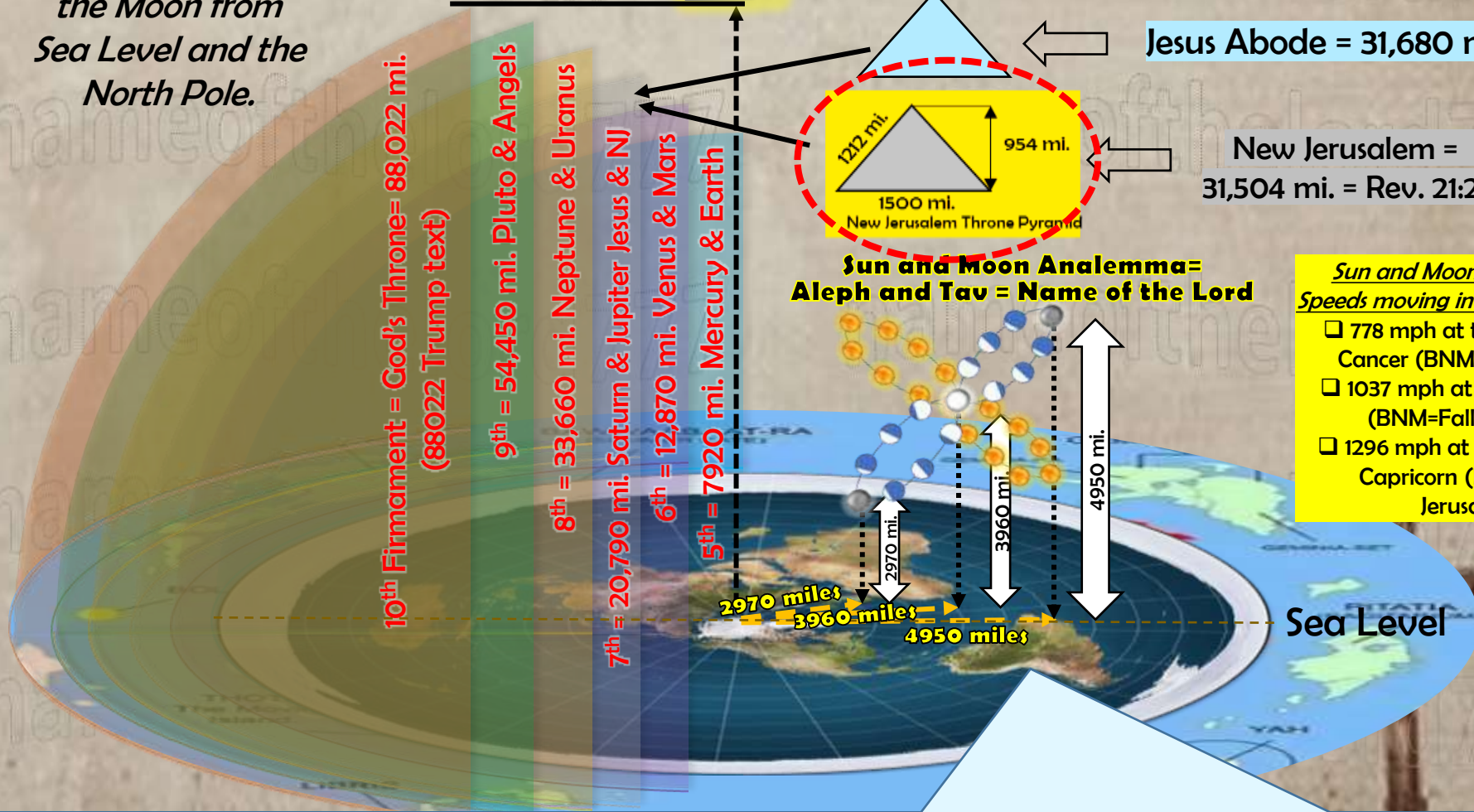

Sea Level

When Traveling the Firmament, the Sun with a complete cycle = 365.24 days changes 10.84 miles in elevation as it travel a Fibonacci curve crisscrossing the Moon down the firmament. The Moon creating the 14 phases changes elevation and increases by 67.05 miles a day with a complete cycle = 59.06 days. Daily snapshots from the same spot will create the Analemma. For

More Details go to [flatearhandthelastdaysblog.wordpress.com](http://flatearhandthelastdaysblog.wordpress.com)

Learn the design procedure  
for the Giza Pyramid and  
you can design Gods Flat  
Earth and New Jerusalem

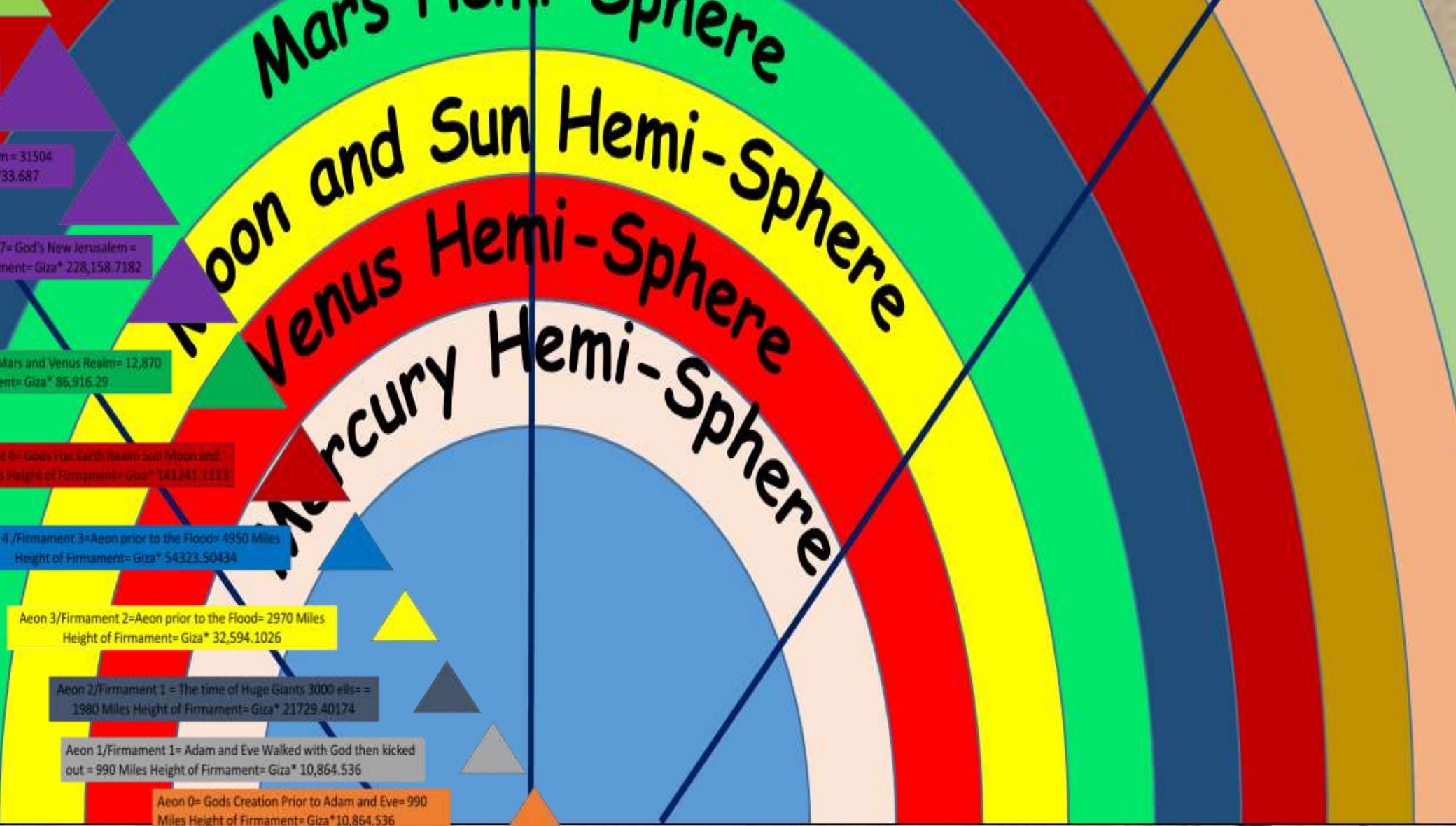

nameofthoia 777



# Global Warming is the Only way to get to the Rolling back of the Scroll and the expansion to the 7<sup>th</sup> aeon and 6<sup>th</sup> Firmament

## Did I mention Santa is an Anagram for Satan

Calculating the Fibonacci extension to Heaven from Giza to Garden of Eden

0	0.091122159	0.09112216	0.0911	0.09	0.091	<b>0.0909</b>	0.091645
1	0.091122159	0.09112216	0.0911	0.09	0.091	<b>0.0909</b>	0.091645
2	0.182244318	0.18224432	0.1822	0.18	0.182	<b>0.1818</b>	0.18329
3	0.273366477	0.27336648	0.2733	0.27	<b>0.273</b>	<b>0.2727</b>	0.274935
4	0.455610795	0.4556108	0.4555	0.45	0.455	<b>0.4545</b>	0.458225
5	0.728977273	0.72897728	0.7288	0.72	0.728	<b>0.7272</b>	0.73316
6	1.184588068	1.18458808	1.1843	1.17	1.183	1.1817	1.191385
7	1.913565341	1.91356536	1.9131	1.89	1.911	1.9089	1.924545
8	3.098153409	3.09815344	3.0974	3.06	3.094	3.0906	3.11593
9	5.01171875	5.0117188	5.0105	4.95	5.005	4.9995	5.040475
10	8.109872159	8.10987224	8.1079	8.01	8.099	8.0901	8.156405
11	13.12159091	13.12159104	13.1184	12.96	13.104	13.0896	13.19688
12	21.23146307	21.23146328	21.2263	20.97	21.203	21.1797	21.353285
13	34.35305398	34.35305432	34.3447	33.93	34.307	34.2693	34.550165
14	55.58451705	55.5845176	55.571	54.9	55.51	55.449	55.90345
15	89.93757102	89.93757192	89.9157	88.83	89.817	89.7183	90.453615
16	145.5220881	145.5220895	145.4867	143.73	145.327	<b>145.1673</b>	146.357065
17	235.4596591	235.4596614	235.4024	232.56	235.144	<b>234.8856</b>	<b>236.81068</b>
18	380.9817472	380.981751	380.8891	376.29	380.471	380.0529	383.167745
19	616.4414063	616.4414124	<b>616.2915</b>	608.85	615.615	614.9385	619.978425
20	997.4231534	997.4231634	997.1806	985.14	996.086	994.9914	1003.14617
21	1613.86456	1613.864576	1613.4721	1593.99	1611.701	1609.9299	1623.124595
22	2611.287713	2611.287739	2610.6527	2579.13	2607.787	2604.9213	<b>2626.270765</b>
23	4225.152273	4225.152315	4224.1248	4173.12	4219.488	4214.8512	4249.39536
24	6836.439986	6836.440054	6834.7775	6752.25	6827.275	6819.7725	6875.666125
25	11061.59226	11061.59237	11058.9023	10925.37	11046.763	11034.6237	<b>11125.06149</b>
26	17898.03224	17898.03242	17893.6798	17677.62	17874.038	17854.3962	<b>18000.72761</b>
27	28959.6245	28959.62479	28952.5821	28602.99	28920.801	<b>28889.0199</b>	<b>29125.7891</b>
28	46857.65675	46857.65721	46846.2619	46280.61	46794.839	46743.4161	47126.51671
29	75817.28125	75817.28201	75798.844	74883.6	75715.64	75632.436	76252.3058
30	122674.938	122674.9392	122645.1059	121164.2	122510.479	122375.8521	123378.8225
31	198492.2192	198492.2212	198443.9499	196047.8	198226.119	198008.2881	199631.1283
32	321167.1572	321167.1604	321089.0558	317212	320736.598	320384.1402	<b>323009.9508</b>
<b>33</b>	<b>519659.3765</b>	<b>519659.3817</b>	<b>519533.0057</b>	<b>513259.8</b>	<b>518962.717</b>	<b>518392.43</b>	<b>522641.08</b>
34	840826.5337	840826.5421	840622.0615	830471.9	839699.315	838776.5685	845651.0299
35	1360485.91	1360485.924	1360155.067	1343732	1358662.032	1357168.997	1368292.109
36	2201312.444	2201312.466	2200777.129	2174204	2198361.347	2195945.565	2213943.139
37	3561798.354	3561798.39	3560932.196	3517935	3557023.379	3553114.562	3582235.248





# Global Warming is the Only way to get to the Rolling back of the Scroll and the expansion to the 7<sup>th</sup> aeon and 6<sup>th</sup> Firmament

## Did I mention Santa is an Anagram for Satan

from Giza size how many fibonnacci cycles until the Garden of Eden?									
0	0.091122159	0.091122159	0.09112216	0.0911	0.09	0.091	0.090		
1	0.091122159	0.091122159	0.09112216	0.0911	0.09	0.091	0.090		
2	0.182244318	0.182244318	0.18224432	0.1822	0.18	0.182	0.181		
3	0.273366477	0.273366477	0.27336648	0.2733	0.27	0.273	0.272		
4	0.455610795	0.455610795	0.4556108	0.4555	0.45	0.455	0.454		
5	0.728977273	0.728977272	0.72897728	0.7288	0.72	0.728	0.727		
6	1.184588068	1.184588067	1.18458808	1.1843	1.17	1.183	1.181		
7	1.913565341	1.913565339	1.91356536	1.9131	1.89	1.911	1.908		
8	3.098153409	3.098153406	3.09815344	3.0974	3.06	3.094	3.090		
9	5.01171875	5.011718745	5.0117188	5.0105	4.95	5.005	4.999		
10	8.109872159	8.109872151	8.10987224	8.1079	8.01	8.099	8.090		
11	13.12159091	13.1215909	13.12159104	13.1184	12.96	13.104	13.089		
12	21.23146307	21.23146305	21.23146328	21.2263	20.97	21.203	21.179		
13	34.35305398	34.35305394	34.35305432	34.3447	33.93	34.307	34.269		
14	55.58451705	55.58451699	55.5845176	55.571	54.9	55.51	55.44		
15	89.93757102	89.93757093	89.93757192	89.9157	88.83	89.817	89.718		
16	145.5220881	145.5220879	145.5220895	145.4867	143.73	145.327	145.167		
17	235.4596591	235.4596589	235.4596614	235.4024	232.56	235.144	234.885		
18	380.9817472	380.9817468	380.981751	380.8891	376.29	380.471	380.052		
19	616.4414063	616.4414056	616.4414124	616.2915	608.85	615.615	614.938		
20	997.4231534	997.4231524	997.4231634	997.1806	985.14	996.086	994.991		
21	1613.86456	1613.864558	1613.864576	1613.4721	1593.99	1611.701	1609.929		
22	2611.287713	2611.28771	2611.287739	2610.6527	2579.13	2607.787	2604.921		
23	4225.152273	4225.152269	4225.152315	4224.1248	4173.12	4219.488	4214.851		
24	6836.439986	6836.439979	6836.440054	6834.7775	6752.25	6827.275	6819.772		
25	11061.59226	11061.59225	11061.59237	11058.9023	10925.37	11046.76	11034.623		
26	17898.03224	17898.03223	17898.03242	17893.6798	17677.62	17874.04	17854.396		
27	28959.6245	28959.62447	28959.62479	28952.5821	28602.99	28920.8	28889.019		
28	46857.65675	46857.6567	46857.65721	46846.2619	46280.61	46794.84	46743.416		
29	75817.28125	75817.28117	75817.28201	75798.844	74883.6	75715.64	75632.43		
30	122674.938	122674.9379	122674.9392	122645.1059	121164.2	122510.5	122375.852		
31	198492.2192	198492.219	198492.2212	198443.9499	196047.8	198226.1	198008.288		
32	321167.1572	321167.1569	321167.1604	321089.0558	317212	320736.6	320384.140		
33	519659.3765	519659.376	519659.3817	519533.0057	513259.8	518962.7	51839		
34	840826.5337	840826.5329	840826.5421	840622.0615	830471.9	839699.3	838776.56		





Global Warming is the Only way to get to the Rolling back of the Scroll and the expansion to the 7<sup>th</sup> aeon and 6<sup>th</sup> Firmament

Did I mention Santa is an Anagram for Satan



12-25-05 THE ANAGRAMMA NUMBER: INTERNAL FIRST SYNCHRONIC



Global Warming is the Only way to get to the Rolling back of the Scroll and the expansion to the 7<sup>th</sup> aeon and 6<sup>th</sup> Firmament





**1 Samuel 2:8 He raiseth up the poor out of the dust, and lifteth up the beggar from the dunghill, to set them among princes, and to make them inherit the throne of glory: for the pillars of the earth are the LORD'S, and he hath set the world upon them.**

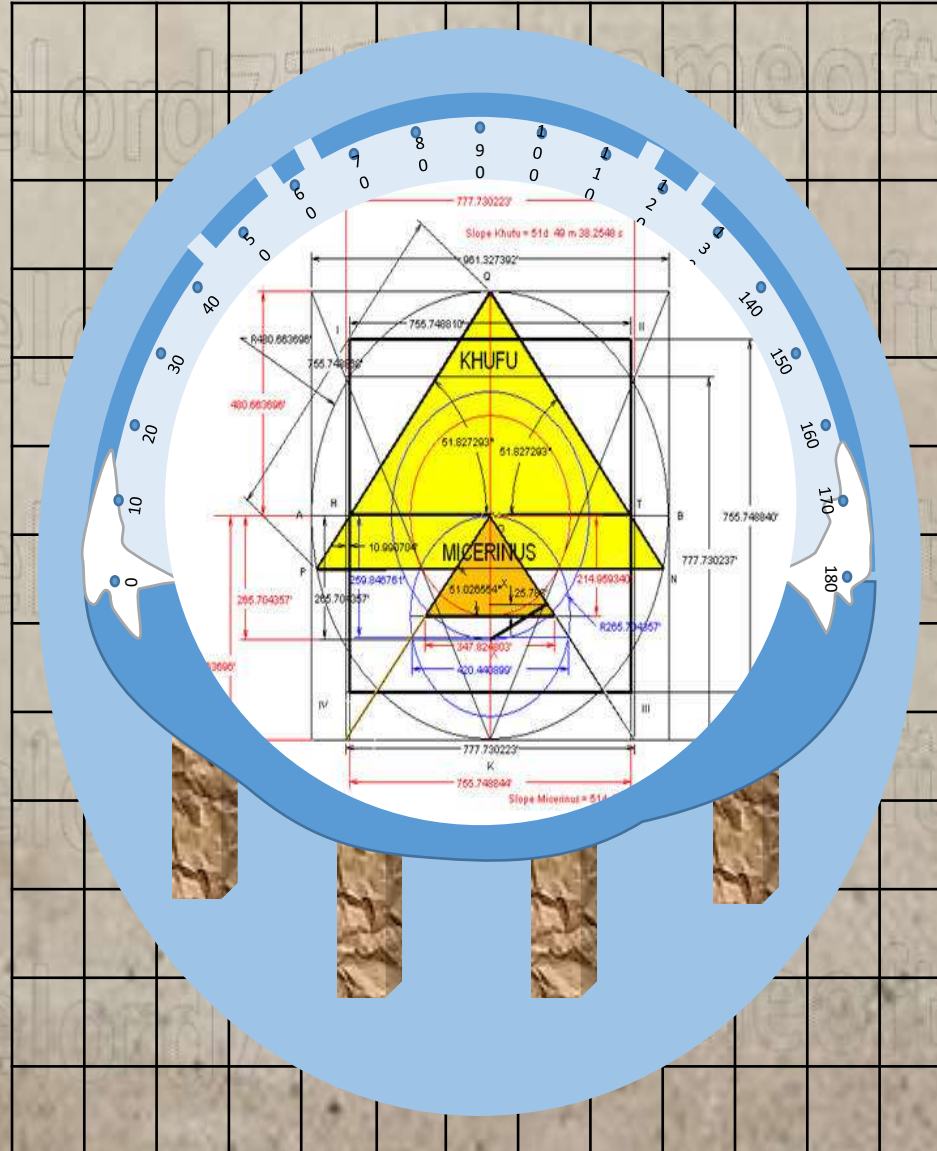

# Helical Path of the Sun in the Firmament

Elevation of the Sun in its Helical Orbit from 3060 miles to 1980 up and out from sea level and North pole. The three Stations represent its travel in its Helical orbit up and down the Firmament of sky in a pyramid shape from Equinox to Solstice.

# Helical Path of the Moon in the Firmament

Elevation of the Moon in its Helical Orbit from 3060 miles to 1980 up and out from sea level and North pole. The three Stations represent its travel in its Helical orbit up and down the firmament of sky in a pyramid shape.

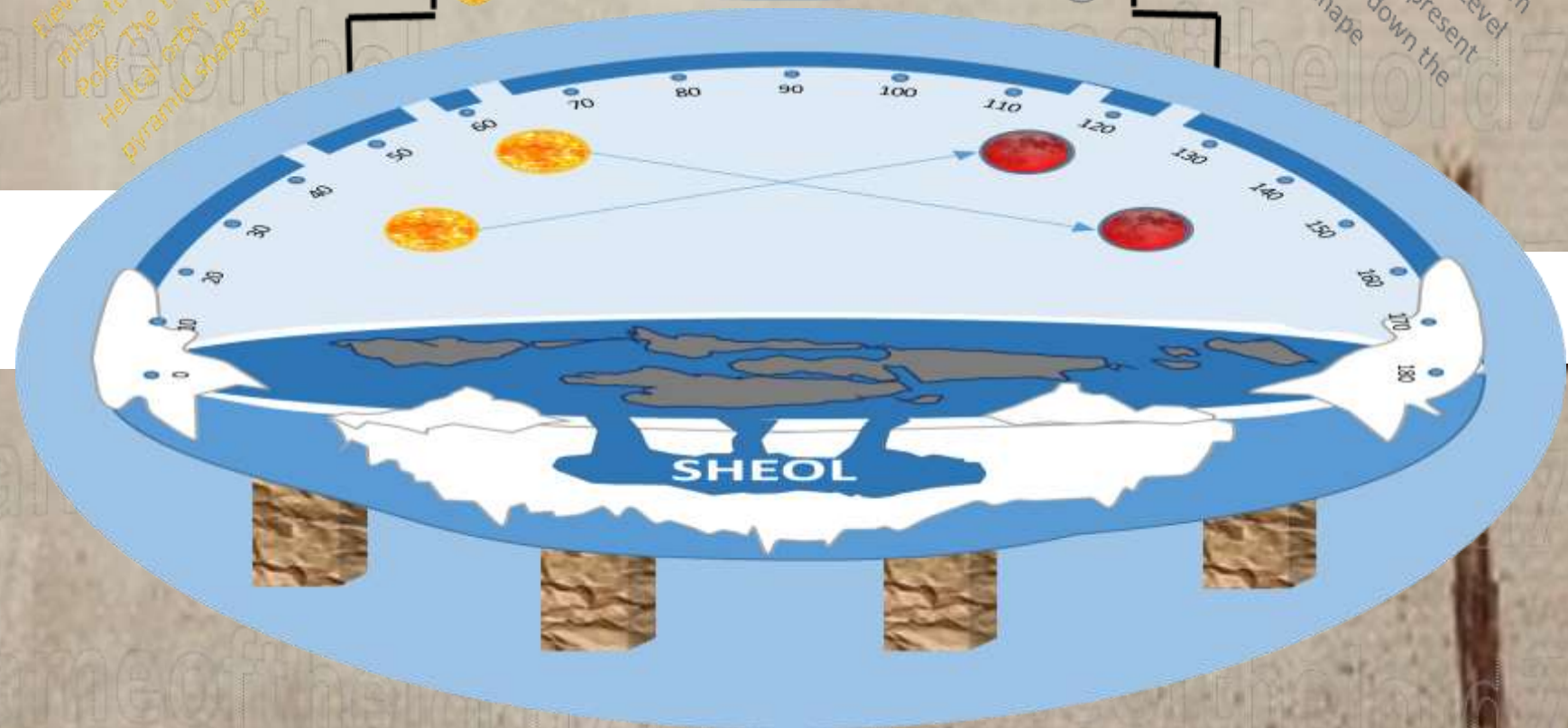
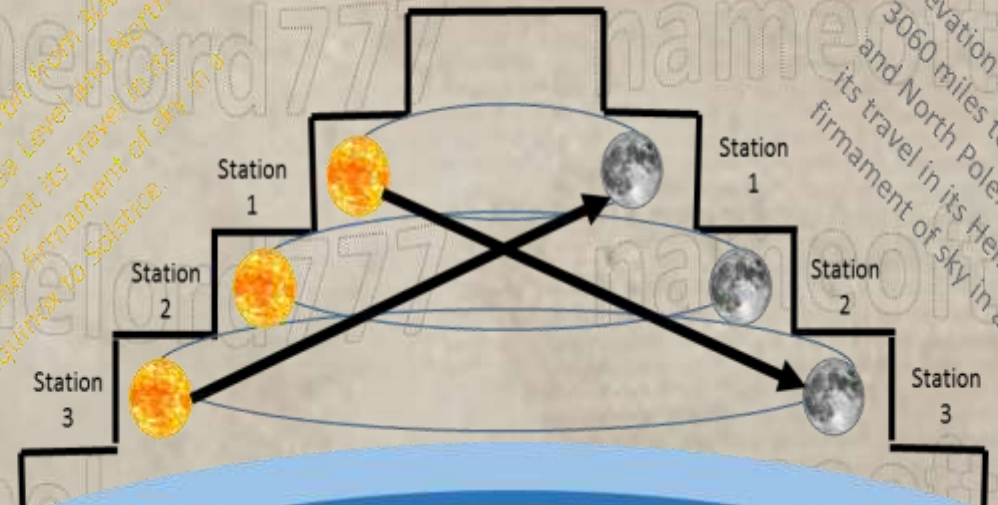



**Genesis 1:6 And God said, Let there be a firmament in the midst of the waters, and let it divide the waters from the waters. 7 And God made the firmament, and divided the waters which were under the firmament from the waters which were above the firmament: and it was so.**

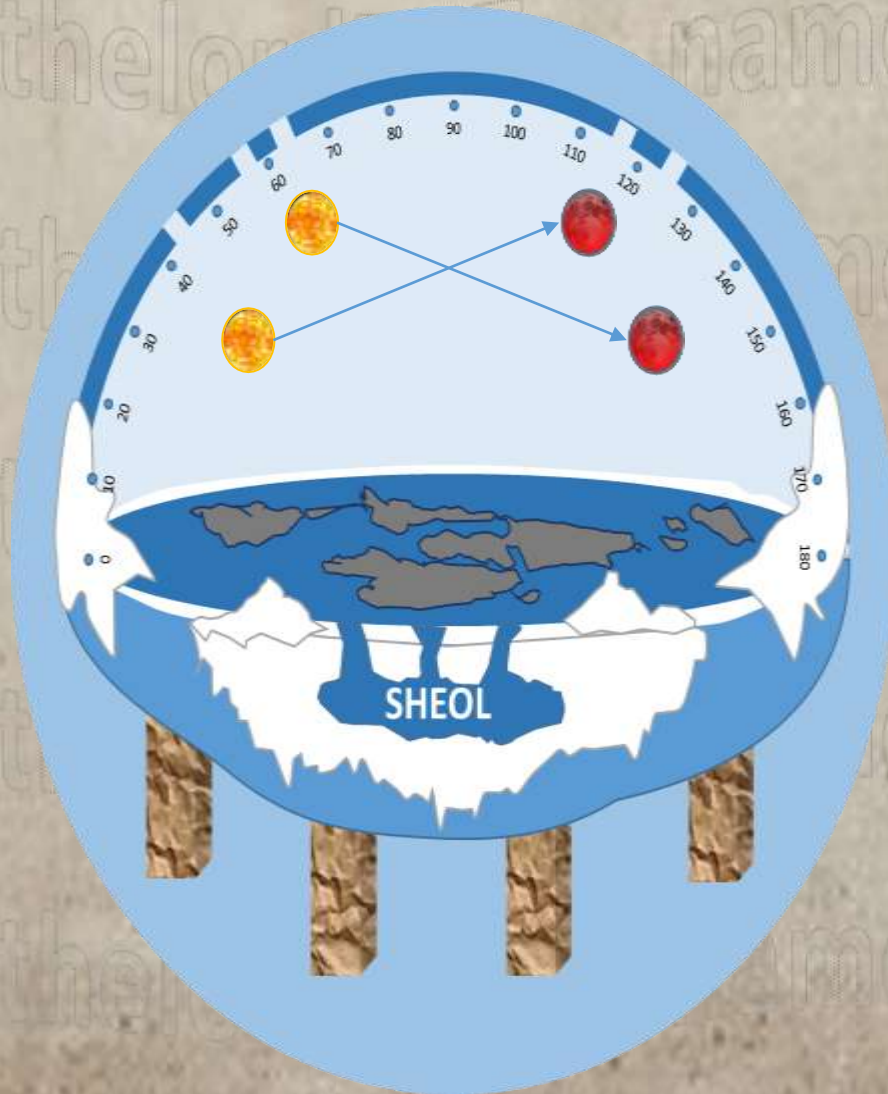



# Acts 2:20 The sun shall be turned into darkness, and the moon into blood, before that great and notable day of the Lord come:

## Blood Moons Explained on a Flat Earth

As the Sun and Moon go about their independent helical cycles around the firmament up and down at various times there can be a point where maximum angle and distance achieve a Blood Moon. The Light of the sun must pass through more atmosphere just like we experience at sun set causing a red sun before it disappears. We see the blood moon at various locations as our reflective Matrix allows the moon to be seen and the sun is at the proper angle to cast a red color.

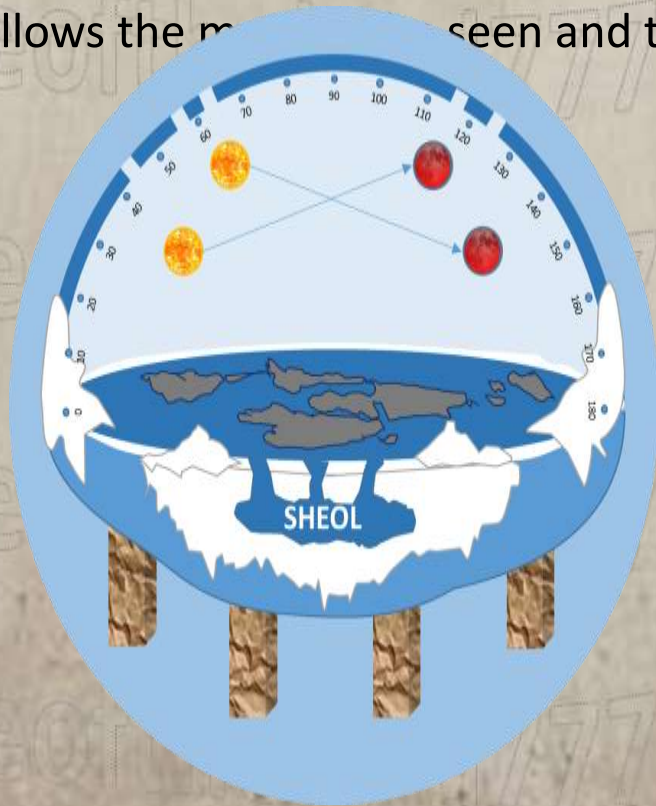



**Acts 2:20 The sun shall be turned into darkness, and the moon into blood, before that great and notable day of the Lord come:**

## **Blood Moons Explained on a Flat Earth**

As the Sun and Moon go about their independent helical cycles around the firmament up and down at various times there can be a point where maximum angle and distance achieve a Blood Moon. The Light of the sun must pass through more atmosphere just like we experience at sun set causing a red sun before it disappears. We see the blood moon at various locations as our reflective Matrix allows the moon to be seen and the sun is at the proper angle to cast a red color.

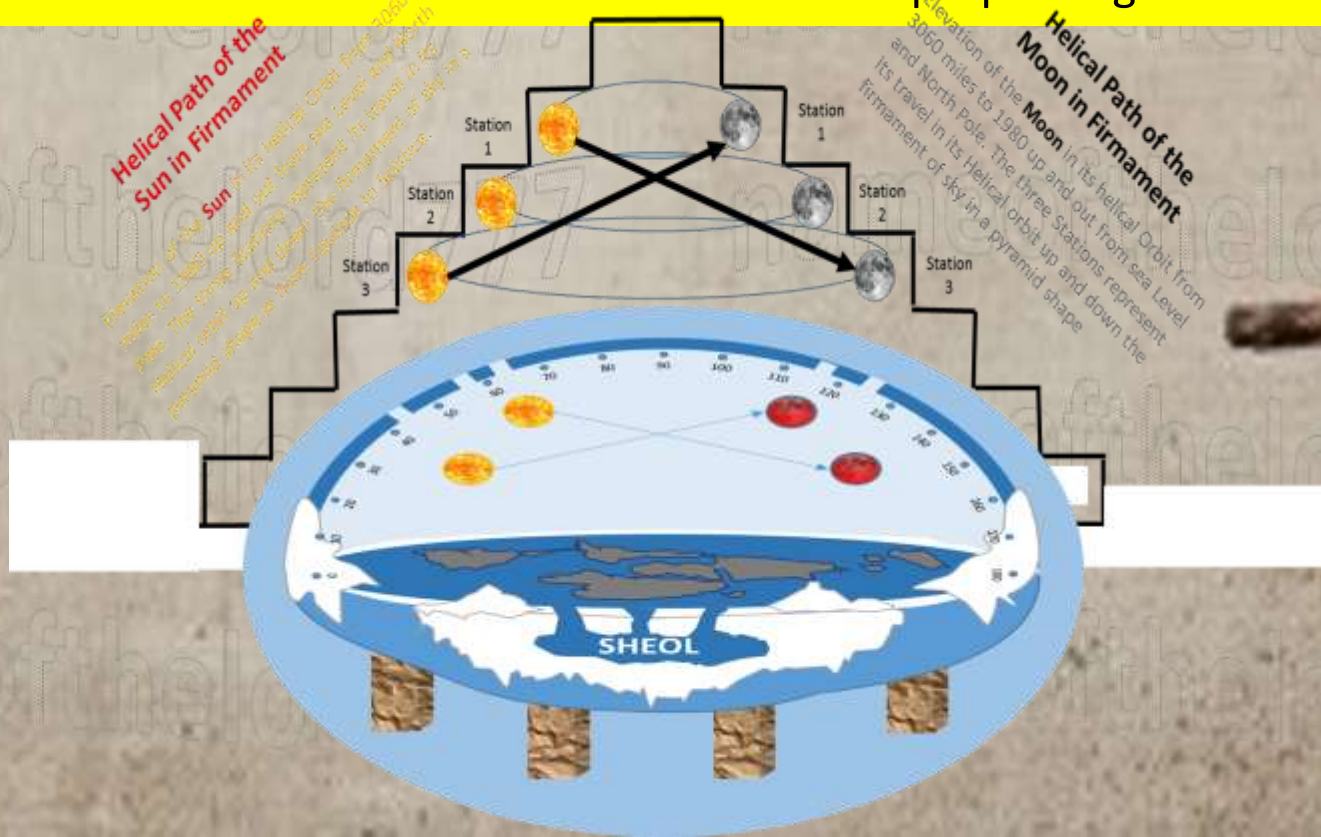



# The Construction of the Giza Pyramid Part 6!!!

THE PYRAMID'S RUINS ARE DEFINED!!!

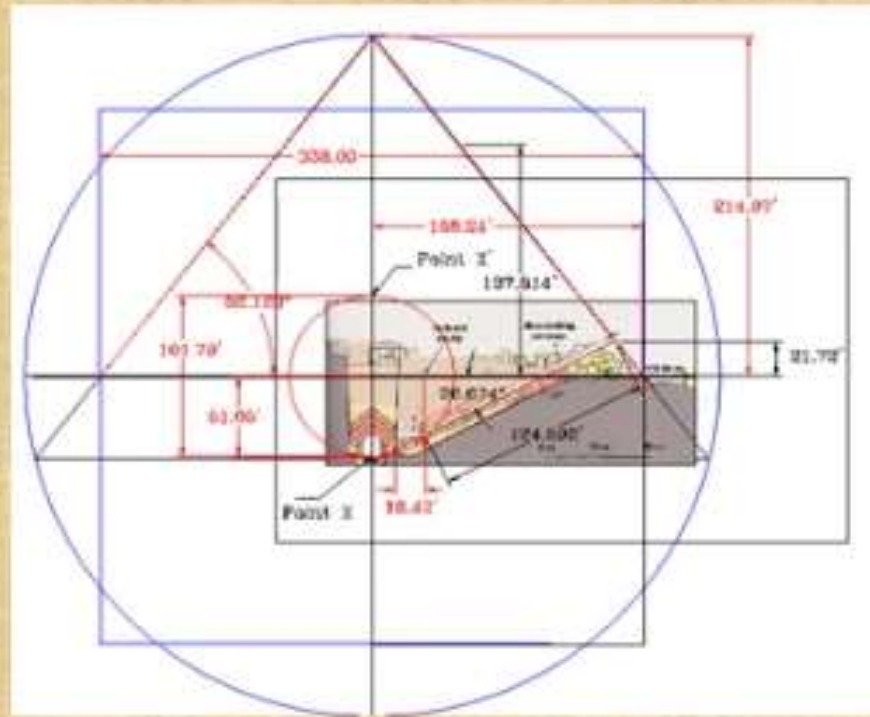

Based on the set up scale, the height of the pyramid is measured as 214.97 ft. The length of the circle's diameter would be = 429.94 ft. The side's lengths of the square are equal to 338 ft.

The formula  $(D / b)$  to determine the tangent of the slope angle indicates that it would be =  $(429.94 / 338.00) = 1.272011834$ . Therefore, the corresponding angle for this tangent function is  $51.82712134^\circ$ , or  $51^\circ 49' 37.64''$ .





# The Construction of the Giza Pyramid Part 6!!!

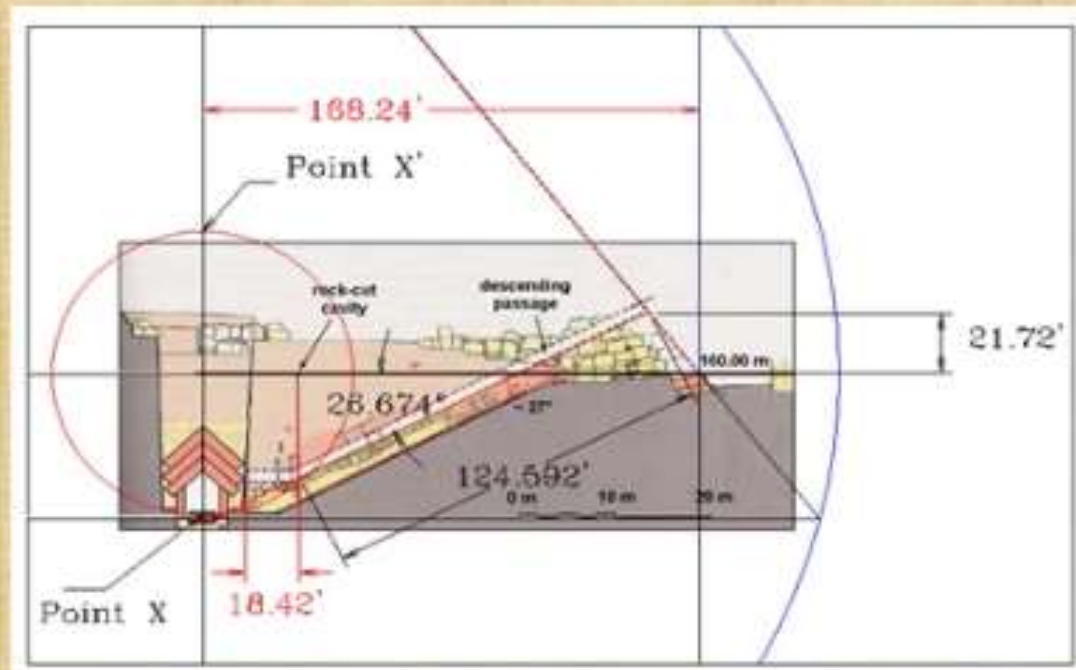

However, there is an important property about this pyramid. Apparently, the circumference of its construction's circle is about equal, to the Perimeter of its base!

Circumference =  $D (\pi) = 129.94 (\pi) = 1,350.70$  ft.

While the perimeter (P) of the base =  $338.00 (4) = 1,352.00$  ft.



# The Construction of the Giza Pyramid Part 6!!!

The difference is =  $(1,352.00 - 1350.696) = 1.30' = 15.4''$ .

Only about 16 inches in 16,224!

These calculations show the apparent intention of the builders of the pyramid to set up the circumference of the circle to be equal to the perimeter of its base. This action is known as **Squaring the Circle in Geometry**, and is one of three Classical geometrical problems coming from ancient Greece times and probable from Egypt.

The properties and characteristics of the ruins of this pyramid are:

The height (=R) of the pyramid is 214.97 ft.

The base sides (b) are 338.00 ft.

The distance (OX) = 50.90'

The vertical distance (X'X) = 101.80'

The descending passage inclined section = 124.59'

The descending passage horizontal section = 18.42

The intended inclined descending passage's angle =  $26.56505118^\circ$

(although it indicates  $27^\circ$  in the drawing).

It is interesting to find from the properties of this pyramid's ruins, by means of the Perfect Symbol and the numerical scale, that the design of this Khufu's son pyramid, follows the same pattern of his father.

# The Construction of the Giza Pyramid Part 6!!!

The Great Pyramid was entirely geometrically designed in the Report Book.

It is important to note the great similarity between this design and that used by his son Djedefre in his pyramid in Abu-Rawash. Both designs were based on the **Perfect Symbol**. In the Great Pyramid, the descending passage inclination was established directly to point X. However, the inclined passage was changed to horizontal before reaching point X, leading to a “fake” subterranean chamber.

Apparently, this was done to direct the robbers in the wrong direction, to find the correct pharaoh's chamber. In Djedefre's pyramid, the Mortuary Chamber and the sarcophagus were placed exactly at point X. The descending passage was slightly changed to horizontal at its end, but anyway, the descending corridor ends at the Mortuary Chamber.

THE GREAT PYRAMID

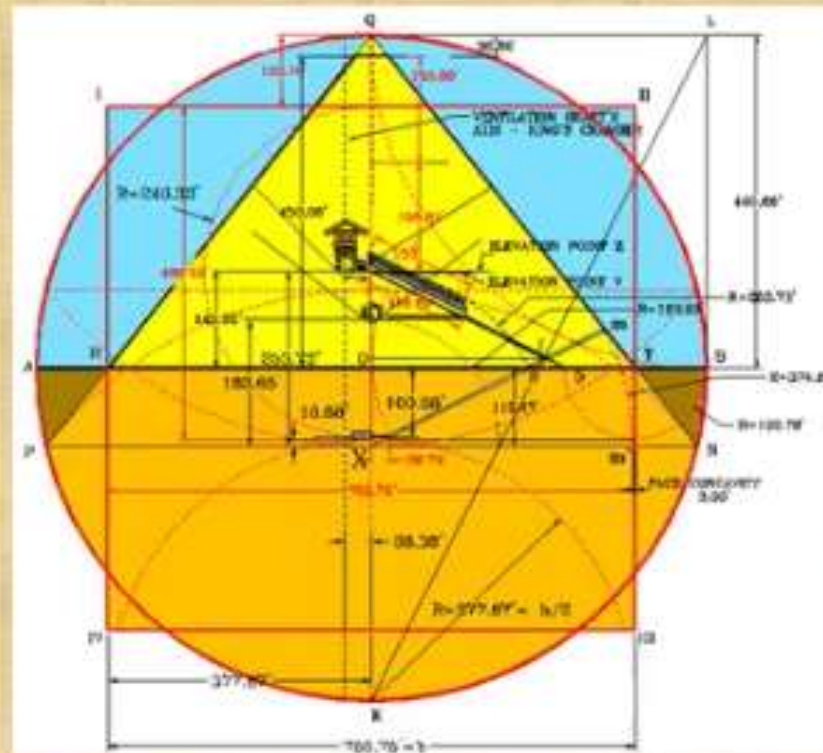



# The Construction of the Giza Pyramid Part 6!!!

## PYRAMID OF CHEPHREN

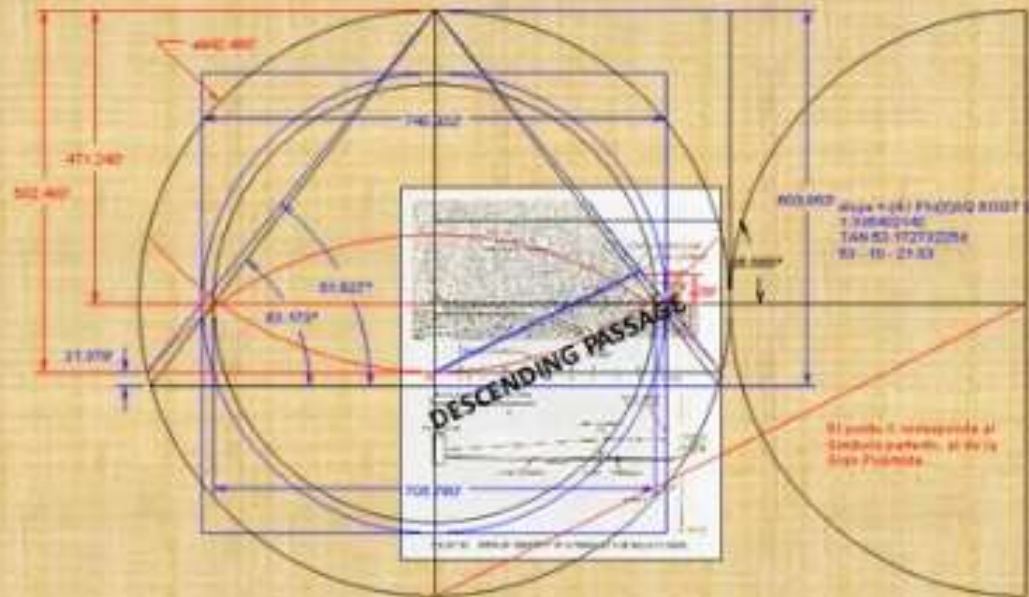

### PRINCIPAL DESCENDING PASSAGE (FROM RECONSTRUCTION)

This pyramid is also entirely design in the Report Book. The design is shown here re-created using a section of the descending passage.



# The Construction of the Giza Pyramid Part 6!!!

The difference is  $= (1,352.00 - 1350.696) = 1.30' = 15.4''$ .

Only about 16 inches in 16,224!

These calculations show the apparent intention of the builders of the pyramid to set up the circumference of the circle to be equal to the perimeter of its base. This action is known as **Squaring the Circle in Geometry**, and is one of three Classical geometrical problems coming from ancient Greece times and probable from Egypt.

The properties and characteristics of the ruins of this pyramid are:

The height (=R) of the pyramid is 214.97 ft.

The base sides (b) are 338.00 ft.

The distance (OX) = 50.90'

The vertical distance (X'X) = 101.80'

The descending passage inclined section = 124.59'

The descending passage horizontal section = 18.42

The intended inclined descending passage's angle =  $26.56505118^\circ$

(although it indicates  $27^\circ$  in the drawing).

It is interesting to find from the properties of this pyramid's ruins, by means of the Perfect Symbol and the numerical scale, that the design of this Khufu's son pyramid, follows the same pattern of his father.



# The Construction of the Giza Pyramid Part 6!!!

The Great Pyramid was entirely geometrically designed in the Report Book.

It is important to note the great similarity between this design and that used by his son Djedefre in his pyramid in Abu-Rawash. Both designs were based on the **Perfect Symbol**. In the Great Pyramid, the descending passage inclination was established directly to point X. However, the inclined passage was changed to horizontal before reaching point X, leading to a "fake" subterranean chamber.

Apparently, this was done to direct the robbers in the wrong direction, to find the correct pharaoh's chamber. In Djedefre's pyramid, the Mortuary Chamber and the sarcophagus were placed exactly at point X. The descending passage was slightly changed to horizontal at its end, but anyway, the descending corridor ends at the Mortuary Chamber

THE GREAT PYRAMID

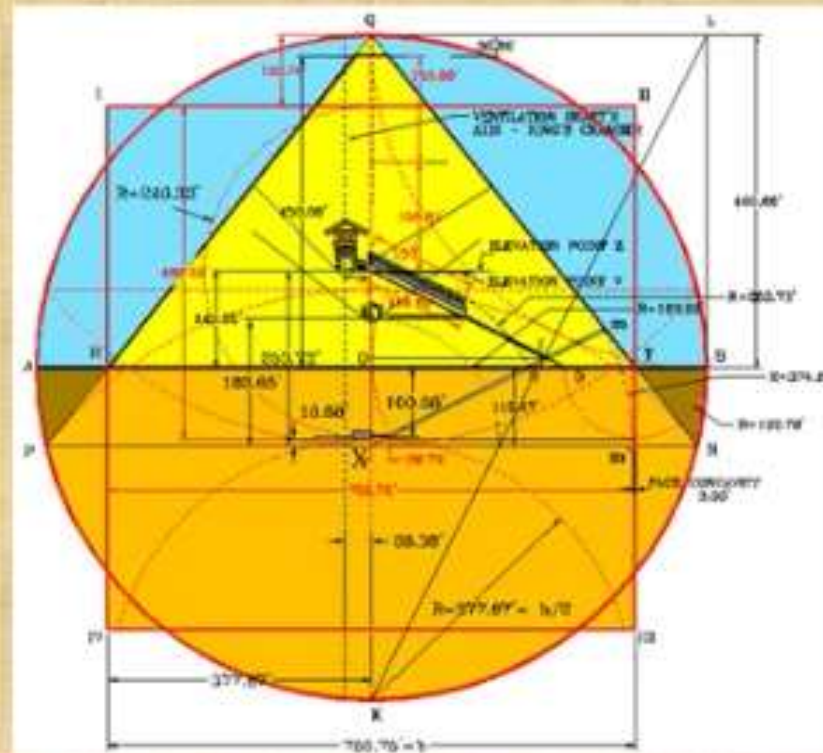



# The Construction of the Giza Pyramid Part 6!!!

## PYRAMID OF CHEPHREN

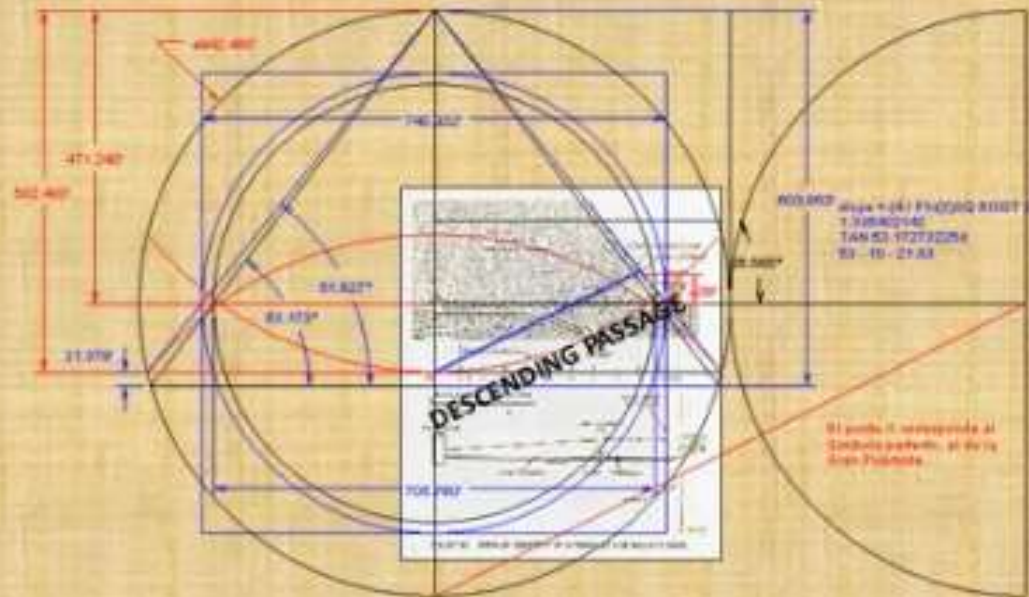

### PRINCIPAL DESCENDING PASSAGE (FROM RECONSTRUCTION)

This pyramid is also entirely design in the Report Book. The design is shown here re-created using a section of the descending passage.



# The Construction of the Giza Pyramid Part 6!!!

## PYRAMID OF MICERINUS

The entire design of this pyramid is also presented in the Report Book.

The geometrical plan is shown here as a reconstruction using a section of the Pyramid. This pyramid is based on the  $\phi$  function, where  $b = R \phi$ . The height of the Pyramid of Micerinus is 214.95 ft.

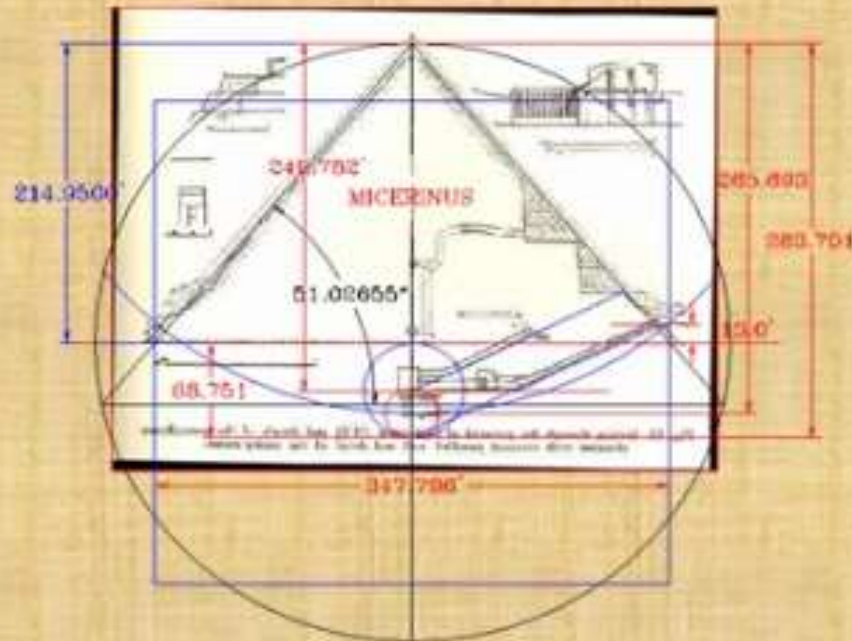

The sides (b) are  $214.95 (\phi) = 347.80$  ft. To determine the location of point X, using the formula  $(X = D / \phi)$ , the result is  $214.95 (2) / \phi = 265.693$  ft. As shown in the previous drawing, this vertical distance represents the location of point X below the pyramid's top, measure in the vertical diameter.





Luke 8:17 For nothing is secret, that shall not be made manifest; neither any thing hid, that shall not be known and come abroad.

## 14 Year Joseph analysis in Parallel with the Last Days and Esther

### The Ark is a Type of Christ

- The ark is a type of Christ—not only the individual Christ but also the corporate Christ, the church, which is the Body of Christ and the new man to consummate in the New Jerusalem

1 Peter 3:21 Which water, as the antitype, also now saves you, that is, baptism, not a putting away of the filth of the flesh but the appeal of a good conscience unto God, **through the resurrecton of Jesus Christ,**

Rev 21:2 And I saw the holy city, **New Jerusalem,** coming down out of heaven from God, **prepared as a bride** adorned for her husband





# The Construction of the Giza Pyramid to The Throne of God

THE GREAT PYRAMID

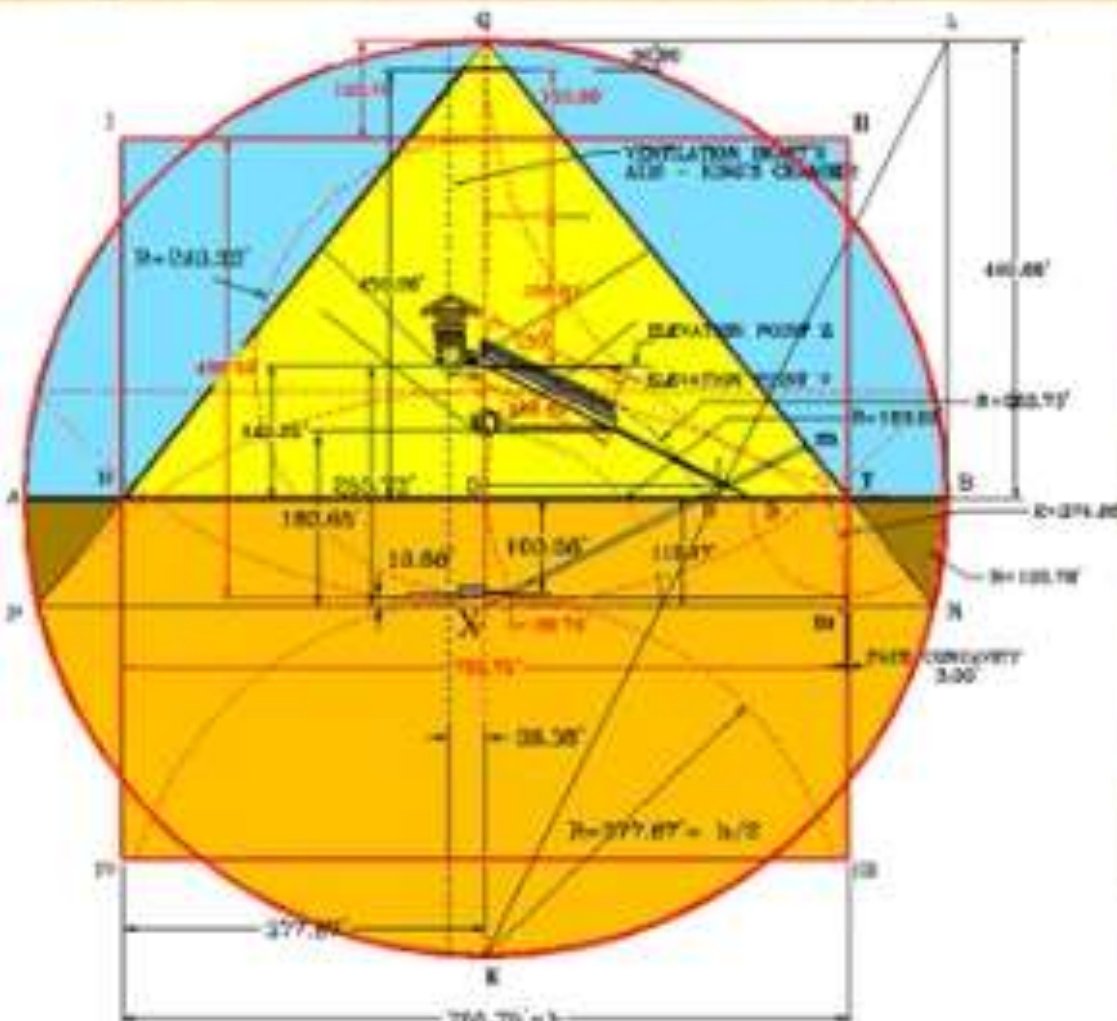

Applying the Giza Pyramid Design as  
Described by Samuel Laboy and how  
that Relates to the Flat Earth and  
Eventually Points to Jesus Returns  
September 23, 2017!!!

Hold On and pray for wisdom to  
Understand it took me 9 Months to  
comprehend this Idea and How it all  
interrelates and I see new connections  
every day!!! This is a Study that is live  
and Growing Study!!!



**Samuel Laboy Designer of the Giza Perfect Symbol and its Application to the Nameofthelord777 Ministry Flat Earth Perfect Design Boss Just in Time for the Return of Jesus!!!**

**The Giza Pyramid Design is Our Blue Print to the Flat Earth Design and the Understanding to Jesus Imminent Return!!!**

Flat Earth Perfect Symbol warning  
September 23, 2017 Seeking God

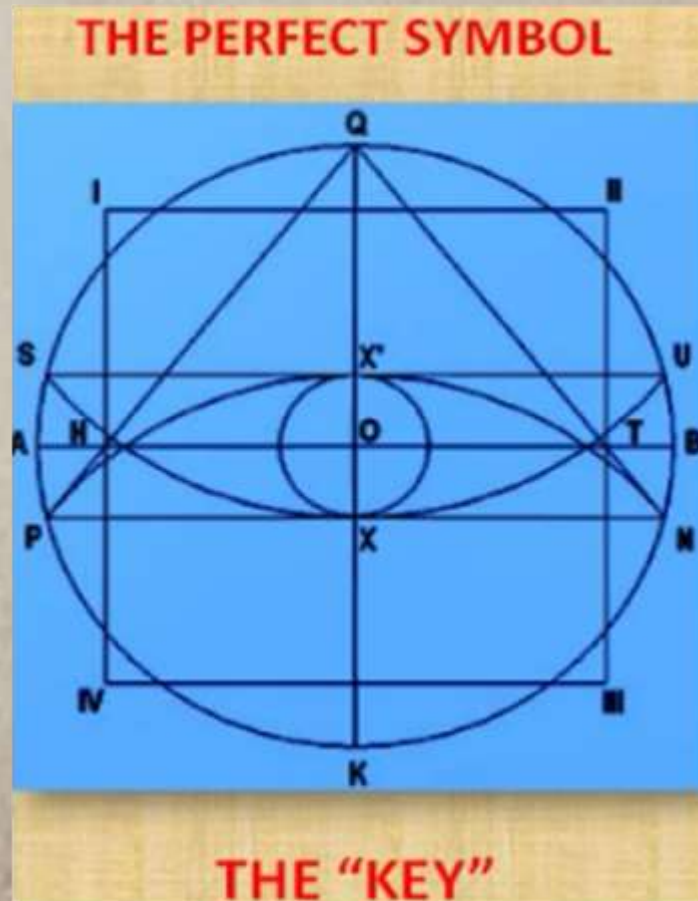
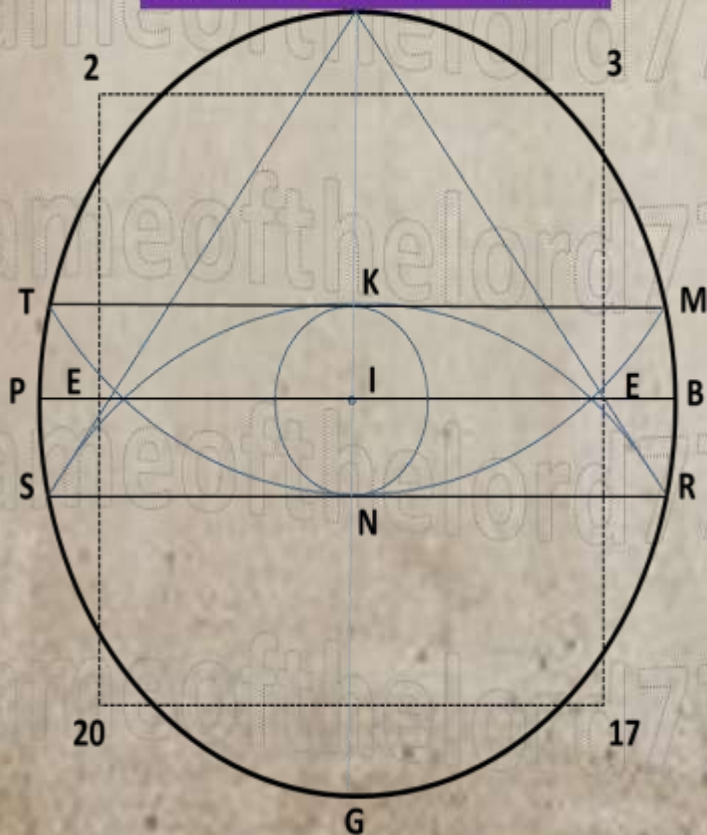



# Samuel Laboy Designer of the Giza Perfect Symbol and its Application to the Name of the Lord 777 Ministry Flat Earth Perfect Design Boss Just in Time for the Return of Jesus!!!

The Giza Pyramid Design is Our Blue Print to the Flat Earth Design and the Understanding to Jesus Imminent Return!!!

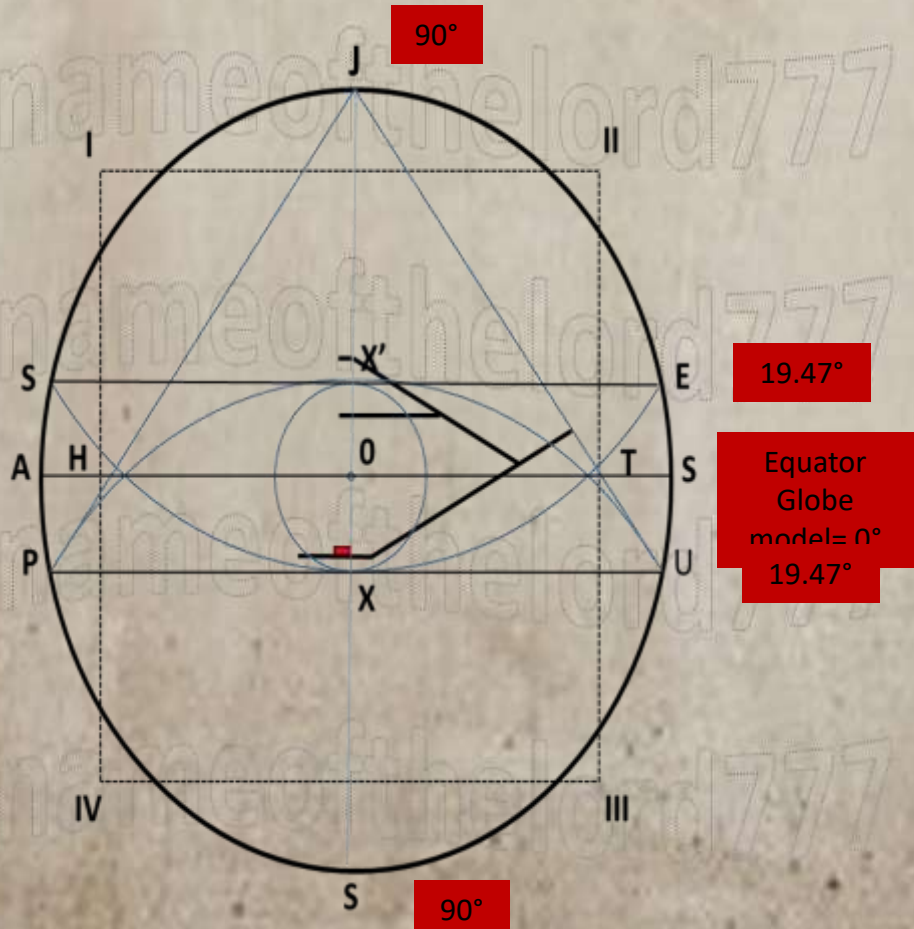

For those that want more information Google Samuel Laboy's Giza Pyramid Design and you will get the details. However if you allow me the liberty of just highlighting this and showing our adaptation and applying to the development of the Flat Earth Model you will see the Great Deception meant to take



# This will show the “Design Boss for the Giza Pyramid” in Feet, Sacred Cubits, Royal Cubits and ALL NEW FLAT EARTH DESIGN MILES?

## Foot Stool of God Never before Designed!!!

Actual Giza Calculations	QO=Height of pyramid	circumference of the Laboy Main Circle	diameter of the Laboy Main Circle	Pi	Phi	Bas e Angl e	Descen ding Angle	Base Calcula tion=2 m.=QO	Phi= K=∅	QX=2r *sin of the base angle=2* b?x(0.78	QN=Base of Pyrami d= 2/√∅x(R) =2/√∅ x(Diam	QT=The Apothem of the pyramid =QT=Height of Pyramid/Sin Angle of pyramid=Q)/	QK=The Diameter of the Circle=2 *Height (C?)			
		3021.58396		3.1431372		51.8	2	1803	6288432	QX'=i5 /Phi						
Actual Giza Numbers in feet	480.663700	0	961.327400	5	1.61803	0.78	629	6003	803	141	9937	8881	0161	611.307098	275.2169	961.327
		3960.00000	24893.6470	7920.00000	3.1431372	0.78	6288	3961.5	8033	6227.404	2378.6	4894.8	10367.	5036.31980	2267.404	
	0	20	0	5	1.61803	432		72303	9	382	56893	29274	41424	1	382470	7920
	7020.00000	40787.2040	15840.0000	3.1431372		0.78		7921.5	1.61	12454.80	7697.4	12452.	12814.	#####	#####	
			00	5	1.61803	63		723	8	876	956	638	828	10072.6396	#####	15840

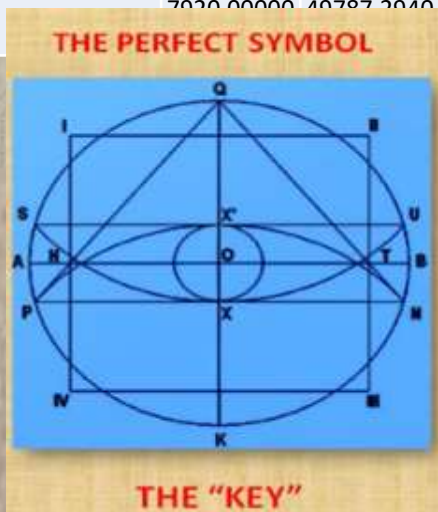

To the Left is Something Developed by Samuel Laboy to explain the divine nature of the Original Giza Pyramid. What we have done in this study is take those numbers and multiply them by a factor and converting to Miles. God gave us Wisdom and Lead us every step of the way to a Complete Design of the Flat Earth!!!



This will show the "Design Boss for the Giza Pyramid" in Feet, Sacred Cubits, Royal Cubits and ALL NEW FLAT EARTH DESIGN MILES?

Foot Stool of God Never before Designed –First in Feet Measurements proportional to Giza Pyramid!!!

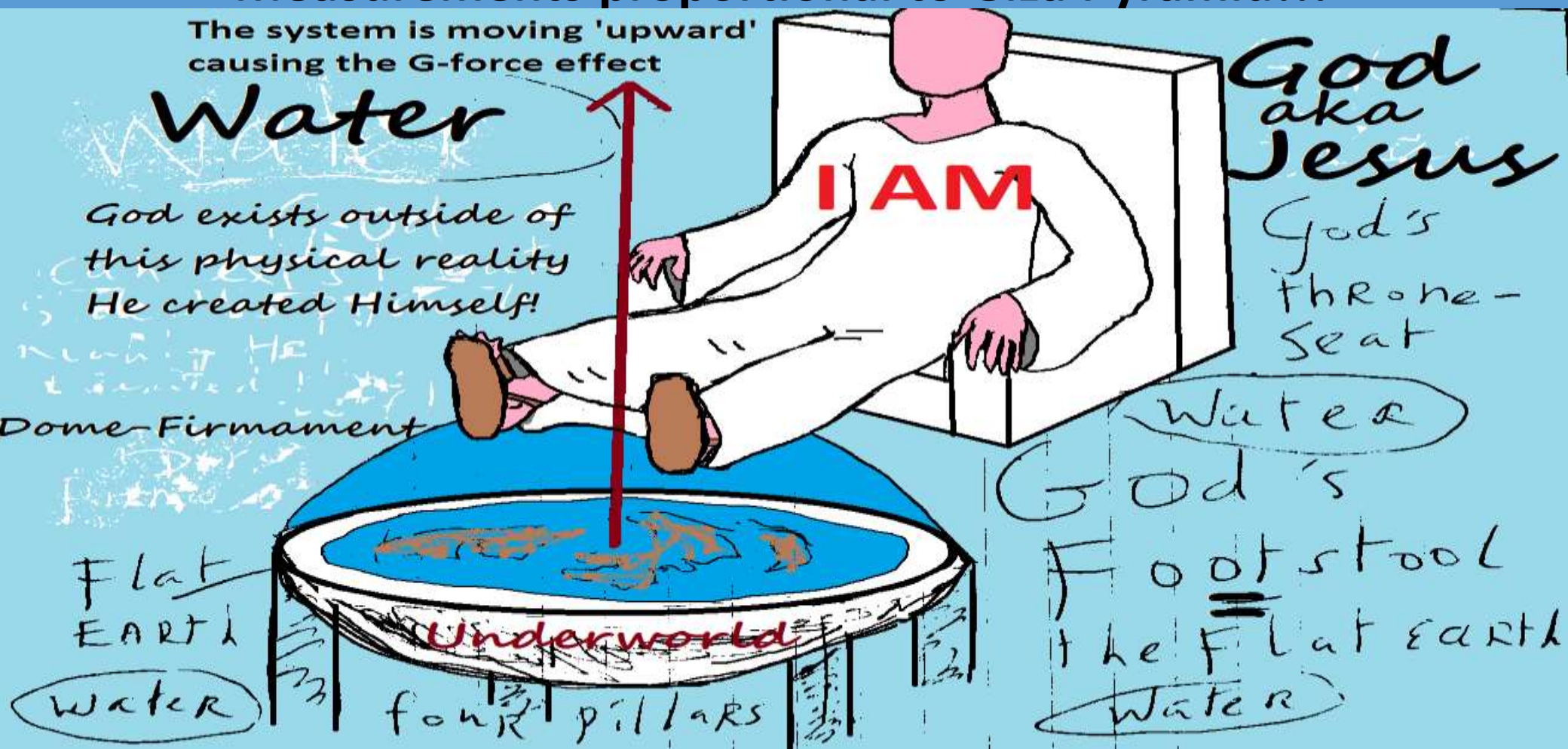



**Job 37:18 Hast thou with him spread out the sky, which is strong, and as a molten looking glass?**

## Volume and width Calculations of the Firmament

### Width of Firmament

Heaven Radius = 8250 Miles

Outer Radius = 7920 Miles

Inner Radius = 7693 Miles

The Width of the Outer and Inner = **227**

Miles

The Width of the Heaven and Inner = **557**

Miles

$$72 \times 72 = 5184$$

$$5184 / 2 = 2592 = \text{time in the Tetrad}$$

$$72^2 / 4 = 1296$$

$$72 \times 360 = 25920 / 2 = 12960$$

$$3 \times 1 \times 4 \times 1 \times 5 \times 9 \times 2 \times 6 \times 5 \times 4 =$$

$$129600$$

Heaven Firmament Wall Length 25920 Miles,

Radius=8250

Outer Firmament Wall Length 24881 Mile, Radius=

7920

Inner Firmament Wall Length 24168 Miles, Radius=

7693

Calculating the Volume of the Firmament=  $\frac{4}{3} \times \text{Pi} \times R^3$

Heaven Hemispherical Volume = 2,352,071,149,834

Cubed Miles

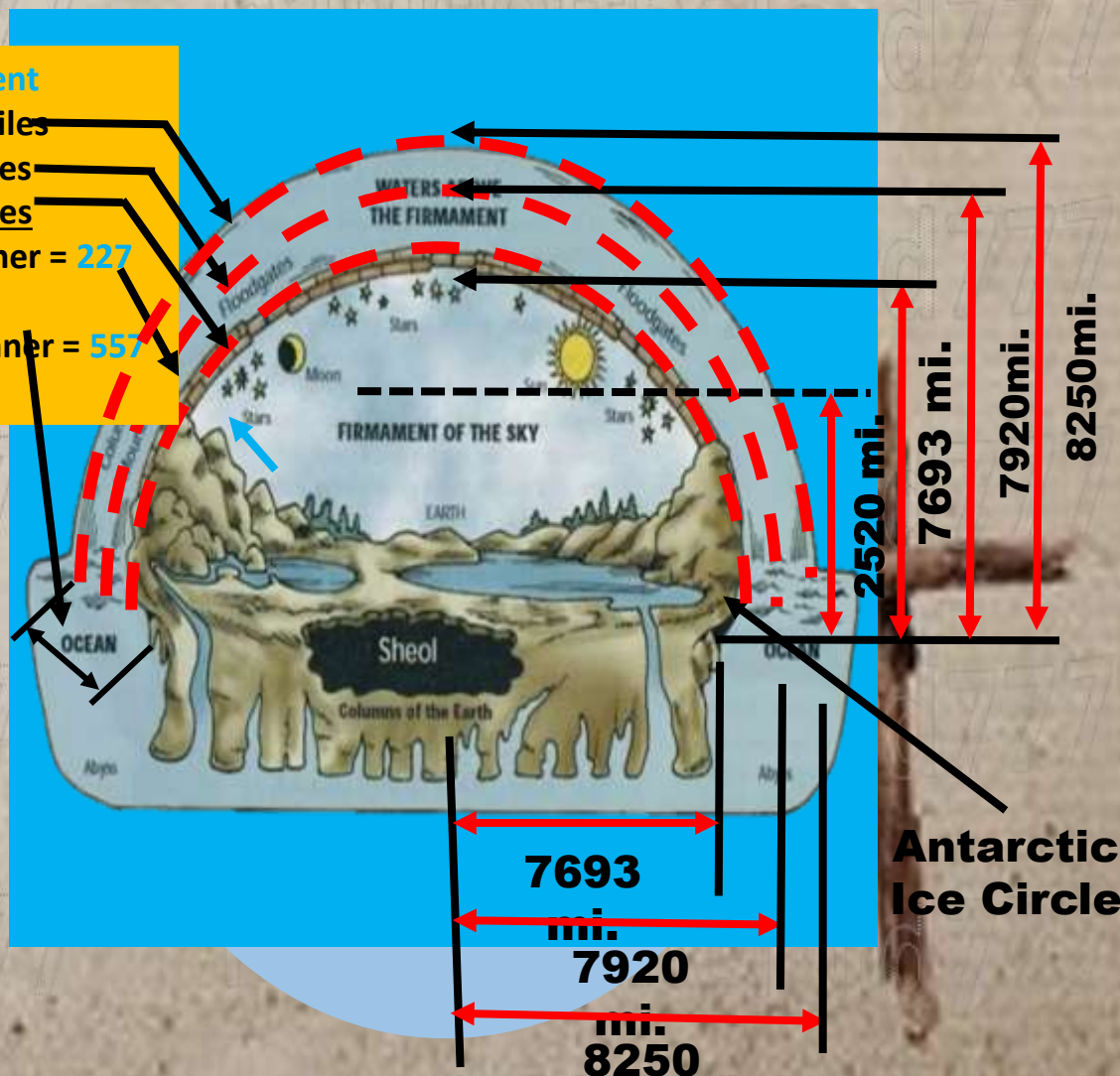





This will show the “Design Boss for the Giza Pyramid” in Feet, Sacred Cubits, Royal Cubits and ALL NEW FLAT EARTH DESIGN MILES?

Foot Stool of God Never before Designed –First in Feet Measurements proportional to Giza Pyramid!!!

Editable Pictures

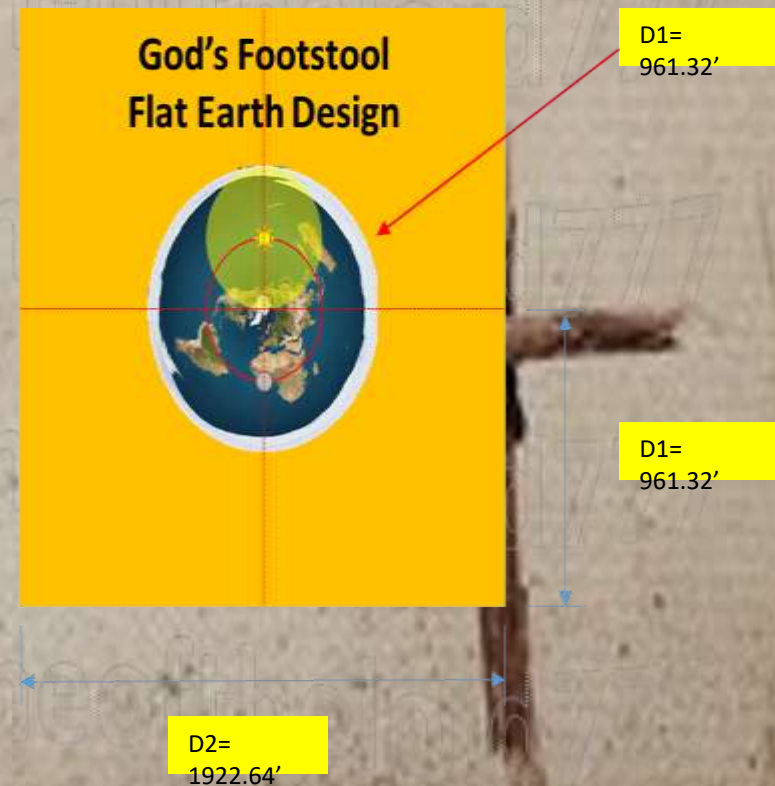
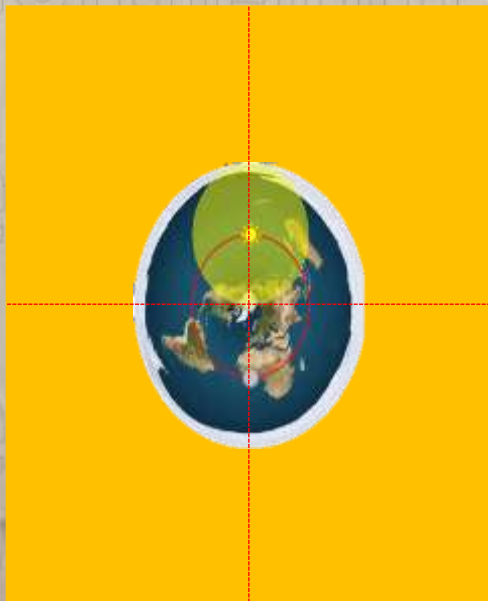



# This will show the “Design Boss for the Giza Pyramid” in Feet, Sacred Cubits, Royal Cubits and ALL NEW FLAT EARTH DESIGN MILES?

**Foot Stool of God Never before Designed –First in Feet Measurements proportional to Giza Pyramid!!!**

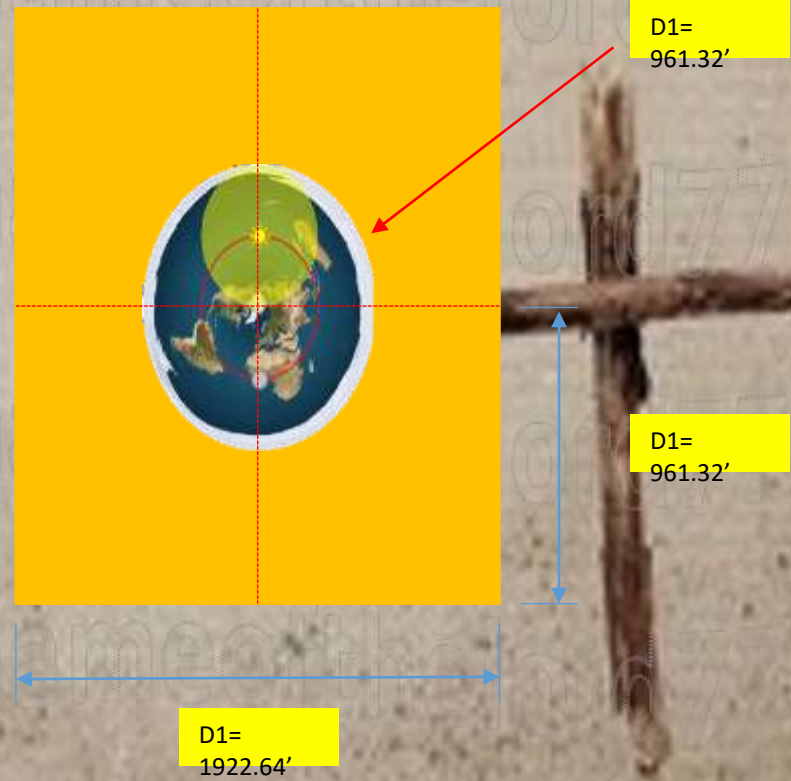
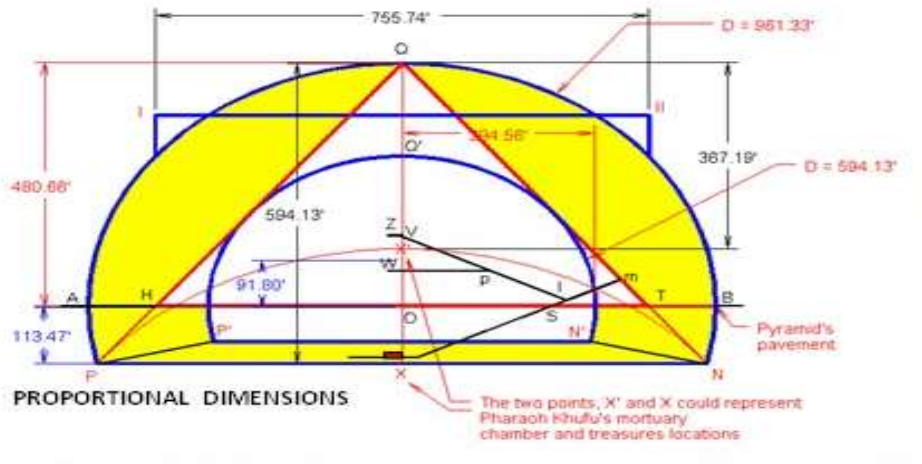



This will show the “Design Boss for the Giza Pyramid” in Feet, Sacred Cubits, Royal Cubits and ALL NEW FLAT EARTH DESIGN MILES?

Foot Stool of God Never before Designed –First in Feet Measurements proportional to Giza Pyramid!!!

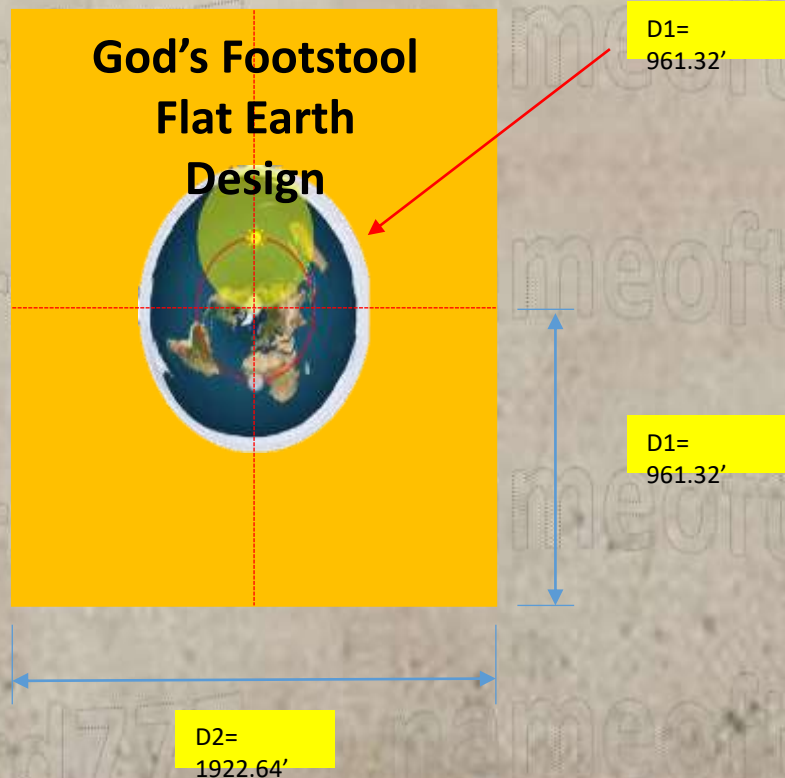

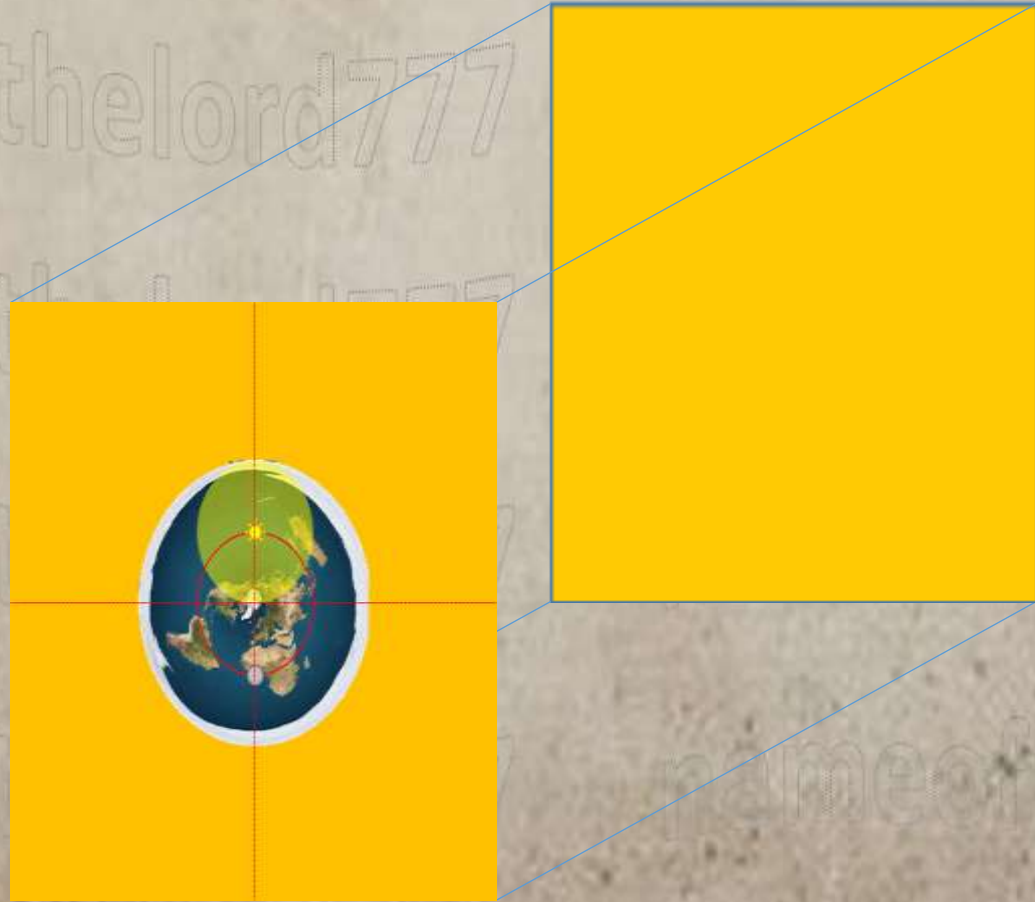



**Genesis 1:16 And God made two great lights; the greater light to rule the day, and the lesser light to rule the night: he made the stars also. 17 And God set them in the firmament of the heaven to give light upon the earth,**

## Flat Earth Hemi Sphere Orbit Firmament Locations

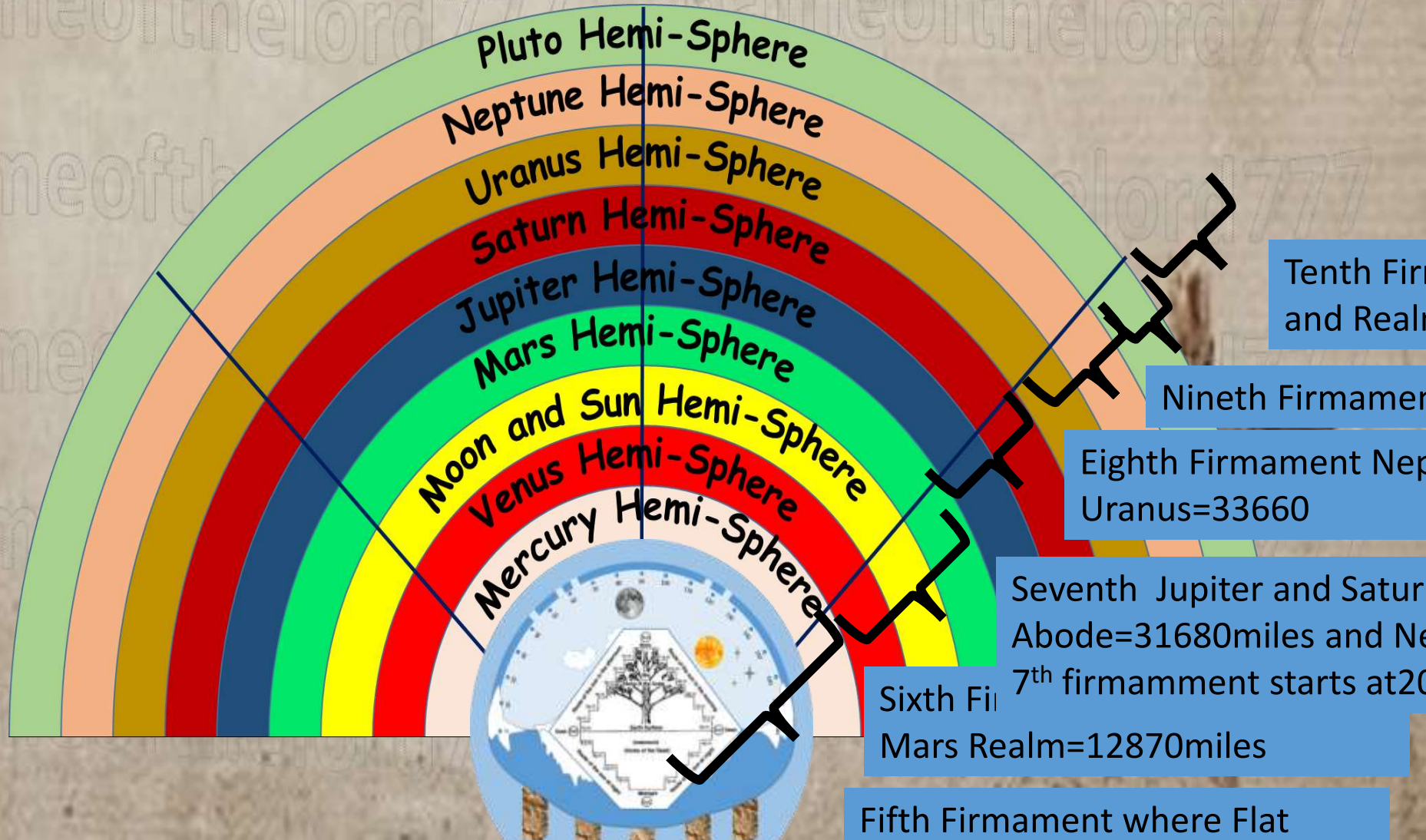

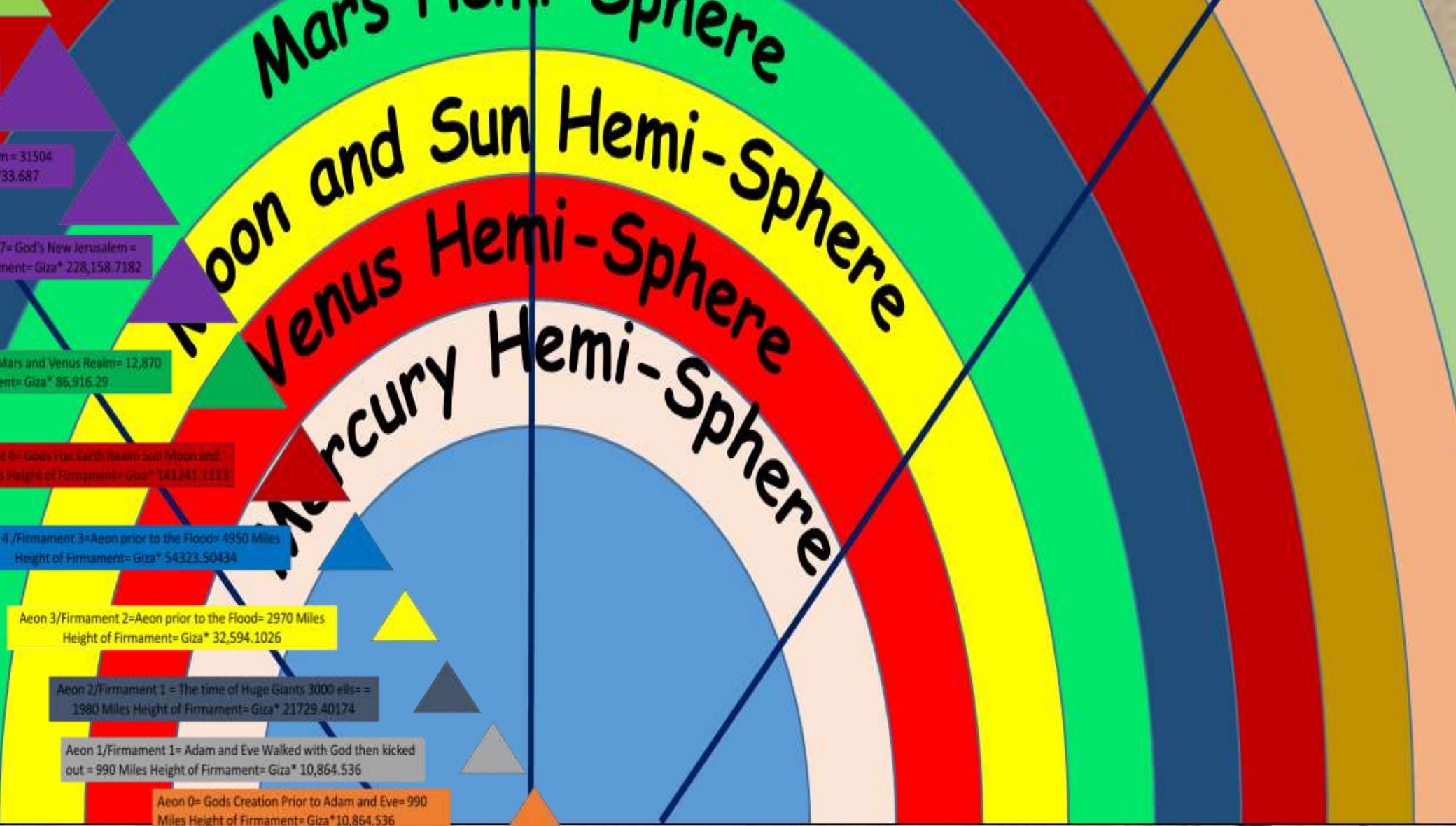

Gods Witness and Testimony Isaiah 19:19 From Giza to the throne of God = .636  
 Height/Base or Base/ Height = 1.572 = half Pi Height = 481.125' or .0911222159 Miles

name of the lord 7:77

name of the lord 7:77



**Luke 8:17 For nothing is secret, that shall not be made manifest; neither any thing hid, that shall not be known and come abroad.**

# Learn the design Procedure for the Giza Pyramid and you can design Gods Flat earth and New Jerusalem and Gods Throne

Year from creation /Height in feet of Giza Pyramid	Firmaments	enter Miles	Royal Cubit =25.2/12	enter feet or convert to =feet	converting feet to miles	Big Pyramid H=height of Pyramid in miles	Firmament Location of New Jerusalem and Jesus Firmament	Big Pyramid small height = Units in Miles	Big Pyramid small height = Units in Miles	Big Pyramid circum of design circle = Units in Miles	Big Pyramid 10 degree circle = Units in Miles	Big Pyramid Apothem=H*1.2717 = Units in Miles	Big Pyramid B=ASE SIDE Length =1.5714*H = Units in Miles	Surface area=Big Pyramid area in column B units = Units in Miles	Surface area=Big Pyramid area in Furlongs= square area	Big Pyramid Volume in column B Units= Units in Miles	Big Pyramid volume in Feet=Miles times 5280*5280 = Units in feet	Big Pyramid Volume in Furlongs= Units in furlongs	Big Pyramid H=height of Pyramid = Units in Miles	New Jerusalem small height = Units in Miles	New Jerusalem circum of design circles= Units in Miles	New Jerusalem 10 degree height = Units in Miles	New Jerusalem small height = Units in Miles	New Jerusalem Apothem height = Units in Miles	New Jerusalem base= Units in Miles	New Jerusalem area in column B units= Units in Miles	New Jerusalem area in Feet=Miles times 5280*5280	New Jerusalem area in Furlongs	New Jerusalem Volume in column B Units= Units in Miles	New Jerusalem volume in Feet= Miles times 5280*5280	New Jerusalem Volume in Furlongs		
Mode l of Flat earth Giza Pyramid=481.125		0.091229	1229.1071429	481.125	0.09122159	0.09122159		0.027349	0.143237	0.572738	0.015909	0.1158876	0.143189	0.053690942	1496817.559	3.436220293	0.000622765	91669743.3	0.32	0.09122159	0.000662	2.00685	0.05567038	0.003412	0.002761	0.003511	0.004339	4.9303E-05	1374.488117	0.003155391	1.73294E-08	2550.845738	0.00
Mode l of Flat earth Giza Pyramid=480.637		0.091034792	1228.887476637	480.637	0.091034792	0.091034792		0.0273256	0.143099	0.572189	0.015894	0.1157765	0.143052	0.053588034	1493948.655	3.429634193	0.000620975	91406318.7	0.32	0.091034792	0.000637	1.99553	0.055510	0.003409	0.002758	0.003508	0.004334	4.92085E-05	1371.853677	0.003149343	1.72796E-08	2543.51556	0.00
Mode l of Flat earth Giza Pyramid=475.5		0.0902056818	1226.4285714	475.5	0.090056818	0.090056818		0.027029726	0.141562	0.566042	0.015723	0.1145327	0.141515	0.052442842	1462022.525	3.356341884	0.000601177	88491958.44	0.31	0.090056818	0.000643	1.93227	0.053374	0.003373	0.002728	0.003470	0.004288	4.81569E-05	1342.536754	0.00308204	1.67286E-08	2462.41919	0.00



**Luke 8:17 For nothing is secret, that shall not be made manifest; neither any thing hid, that shall not be known and come abroad.**

# Learn the design Procedure for the Giza Pyramid and you can design Gods Flat earth and New Jerusalem and Gods Throne

Aeon	years from creation/Height in feet of Giza Pyramid	Firmaments	enter Miles	Royal Cubit =25.2/12	enter feet to -feet	converting feet to miles	Big Pyramid H=height of Pyramid in miles	Firmament Location of New Jerusalem and Jesus Firmament	Big Pyramid small ph height = Units in Miles	Big Pyramid small 594 height = Units in Miles	Big Pyramid circum of design circle = Units in Miles	Big Pyramid 10 degree circle = Units in Miles	Big Pyramid apothem 5 H*1.2717 8316 = Units in Miles	Big Pyramid 9-P=BASE SIDE Length=1.5714 *H = Units in Miles	Surface area=Big Pyramid area in Units in Miles	Surface area=Big Pyramid area in Feet=Mile s times 5280*5280 = square feet	Surface area=Big Pyramid area in Furlongs square area	Big Pyramid Volume in column b Units in Miles	Big Pyramid volume in Feet=Miles times 5280*5280* Units in feet	Big Pyramid Volume in Furlongs= Units in furlongs	Big Pyramid H=height of Pyramid= Units in Miles	New Jerusalem small ph height= Units in Miles	New Jerusalem circum of design circle= Units in Miles	New Jerusalem 10 degree circle= Units in Miles	New Jerusalem small 594 height= Units in Miles	New Jerusalem height= Units in Miles	New Jerusalem Apothem height= Units in Miles	New Jerusalem base= Units in Miles	New Jerusalem area in column B units= Units in Miles	New Jerusalem area in Feet=Miles times 5280*5280	New Jerusalem area in Furlongs	New Jerusalem Volume in column b Units= Units in Miles	New Jerusalem volume in Feet=Mile s times 5280*5280	New Jerusalem Volume in Furlongs
1st Aeon	0	1st Firmament	7920.12	2489.1806	5227.279	990.015	990.015		297.1439056	1556.228251	6222.633945	172.8509429	1259.084346	1555.709571	6337771.404	1.76687E+14	405617369.9	798688750	1.17565E+20	4089286400015.71	990.015	7.080107273	2.57028E+12	7139023	37.0182	30.0045	38.15407108	47.14271427	5819.808452	1.62247E+11	372467.7409	22224.69182	3.27143E+15	11379042.21
2nd Aeon	5184	1st Firmament	7920.12	2489.1806	5227.279	990.015	990.015		297.1439056	1556.228251	6222.633945	172.8509429	1259.084346	1555.709571	6337771.404	1.76687E+14	405617369.9	798688750	1.17565E+20	4089286400015.71	990.015	7.080107273	2.57028E+12	7139023	37.0182	30.0045	38.15407108	47.14271427	5819.808452	1.62247E+11	372467.7409	22224.69182	3.27143E+15	11379042.21
3rd Aeon	10368	2nd Firmament	1584.024	4978.361	1045.14558	1980.03	1980.03		594.2878112	3112.456503	12445.26789	345.701858	2518.168691	3111.419142	2535108.562	7.06748E+14	16224669479	6389510000	9.40523E+20	3271429120125.66	1980.03	14.16021622E	2.05173E	5.716112E	74.10090814	60.008148542	76.308148542	94.2855	23279.23381	6.48988E+11	148987.0964	177797.5346	2.61714E+16	91032337.71
4th Aeon	1552	3rd Firmament	2376.036	7467.5417	1568.1838	2970.045	2970.045		891.4317168	4668.684754	18667.90183	518.5528287	3777.253037	4667.128713	57039942.64	1.59018E+15	3650556329	21564596251	3.17426E+20	11041073280424.10	2970.045	21.24032975E	6.93771E	1.922416E	111.01364622	90.042281	114.46224281	141.4281	52378.27607	1.46022E+12	3352206.9668	600066.6792	8.83286E+16	307234139.76
5th Aeon	20736	4th Firmament	3960.06	1244.5903	2613.6396	4950.075	4950.075		1485.719528	7781.141257	31113.16257	864.2547146	6295.4217547	7778.547855	158444285.1	4.41717E+15	10140434246	99836093754	1.46957E+20	51116080001963.40	4950.075	35.40053285E	3.21457E	8.924028E	185.00227703	150.77037135	235.7135	145495.2113	4.05617E+12	931169277808	2778086.478	4.08929E+17	1422380276.65	
6th Aeon	25920	5th Firmament	6336.096	1991.3445	4181.8234	7920.12	7920.12		2377.151245	12449.82107	49781.07156	1382.807543	10072.67477	12445.67657	405617369.9	1.1308E+16	25959511671	4.08929E+15	6.01935E+20	209371463688042.00	7920.12	56.64085598E	1.31551E	3.656444E	296.003664	305.2325687	377.1417	372467.7409	1.03838E+13	23837935.42	11379042.21	1.67497E+18	5826069613.16	
7th Aeon	31104	6th Firmament	102961.569	3235.9347	6795.4630	12870.195	12870.195		3862.870773	2023.096727	80894.24	2247.062	16368.09649	20224.22	1071083367	2.98601E+16	68549335506	1.75472E+15	2.58291E+20	898416222114508.00	12870.195	92.04139E	5.6515E	1.570473E	482.3900059	496.00298553	612.8553	983547.6284	2.74197E+13	62947048.22	48827647.93	7.18733E+18	24999755742.40	
8th Aeon	36288	7th Firmament	166322.52	5227.2792	1.1E+08	20790.315	20790.315		6240.0218	3268.79328	130675.3	3629.869801	26440.77126	32669.9099	2794957189	7.79189E+16	1.78877E+11	7.39666E+12	1.08877E+20	3787088135185460.00	20790.315	148.6822033E	2.38204E	6.616917E	778.630095	801.23549969	989.997	2566535.527	7.15509E+13	164258205822	205822871	3.02967E+19	105381309936.43	





**Luke 8:17 For nothing is secret, that shall not be made manifest; neither any thing hid, that shall not be known and come abroad.**

# Learn the design Procedure for the Giza Pyramid and you can design Gods Flat earth and New Jerusalem and Gods Throne

Aeons	years from creation/Height in feet of Giza Pyramid	Firmaments	enter Miles	Royal Cubit =25.2/12	enter feet or convert to =feet	converting feet to miles	Big Pyramid H=height of Pyramid in miles	Firmament Location of New Jerusalem and Jesus Firmament	Big Pyramid small phi height = Units in Miles	Big Pyramid small 594 height = Units in Miles	Big Pyramid circum of design circle = Units in Miles	Big Pyramid 10 degree circle = Units in Miles	Big Pyramid apothem 581*1.27178316 = Units in Miles	Big Pyramid s=P+BASE SIDE Length=1.5714*H= Units in Miles	Surface area=Big Pyramid area in column 8 units = Units in Miles	Surface area=Big Pyramid area in feet=Miles times 5280*5280= square feet	Surface area=Big Pyramid area in Furlongs= square area	Big Pyramid Volume in column b Units= Miles	Big Pyramid volume in Feet=Miles times 5280*5280* Units in feet	Big Pyramid Volume in Furlongs= Units in Furlongs	Big Pyramid H=height of Pyramid= Units in Miles	New Jerusalem small phi height= Units in Miles	New Jerusalem circum of design circles= Units in Miles	New Jerusalem 10 degree circle= Units in Miles	New Jerusalem small 594 height= Units in Miles	New Jerusalem height= Units in Miles	New Jerusalem Apothem height= Units in Miles	New Jerusalem bases= Units in Miles	New Jerusalem area in column 8 units= Units in Miles	New Jerusalem area in Feet=Miles times 5280*5280	New Jerusalem area in Furlongs	New Jerusalem Volume in column b Units= Units in Miles	New Jerusalem volume in Feet=Miles times 5280*5280	New Jerusalem Volume in Furlongs		
		New Jerusalem Realm=31504 pyramid between the 7th firmament and the 8th firmament. Right below Jewus Home at 31680.	252032	79210057	1.66E+08	31504	31504	7.83241544	945636129	4952189091	19801504	550041777	4006625478	495053856	6417773989	1.78917E+11	4.10738E+11	2.57365E+13	3.78836E+24	13177083569503800.00	31504	225301333	8.28232E+16	2.30064E+15	11799667	95466667	1214128933	15001632	5893272717	1.64295E+14	377169453.9	728225810.1	161555	417E+20	1.05417E+20	366671774758.71
		Jesus Realm=31680 pyramid between the 7th firmament and the 8th firmament. Right below Jewus Home at 31680.	253440	79652571	1.67E+08	31680	31680	7.846116551	9508460911	4979854952	1991212692	5531146368	40294978612	49781952	6489681259	1.80922E+11	4.1534E+11	2.61702E+13	3.85221E+24	13399164613869600.00	31680	22656	8.4219E+16	2.33942E+15	1186960	960911776	1220544	15085959303268	1.66136E+14	381395409.2	728225600	133954195	193E+20	1.07193E+20	372851507189.51	
9th Aeon	41472	8th Firmament	269284.08	84632139	1.78E+08	3366051	3366051	1010289279	529176055	211569541	5876932059	428088676541	5289412541	7326463743	2.0425E+11	4.68894E+11	3.13917E+13	4.62079E+24	16072531267177300.00	3366051	240473	1.0117E+16	2.8015E+15	1260455102	1020417285	1297417285	1602238852	672769857	1.87557E+14	430572708.5	873519287.4	12858E+20	447241875147.55			
10th Aeon	46656	9th Firmament	435606.6	136904931	2.88E+08	54450825	54450825	1634291481	8559255382	342244887	95068019639	6924402641	855685641	19171758497	5.34478E+11	1.2269E+12	1.32882E+13	1.95599E+24	68035502482613200.00	54450825	38963E+17	4.2717E+16	1.1878E+15	20394309	165091285	209847391	259285	1760492057	4.90797E+14	1126714916	13697633102	544284E+20	1893188148220.87			
11th Aeon	5184	10th Firmament	704890.68	22153707	4.65E+08	88111335	88111335	264458043	1385043	5538144	1538373	112058.5	138458.1	50201487291	1.39954E+12	3.2129E+12	5.63051E+13	8.28799E+24	28828201442323388111.0000	88111335	6301295	1.81197E+16	5.03324E+15	3300040	2670712701	33954195	4609870275	1.28516E+15	2950316976	15667718770	230626E	8021872009996.18				

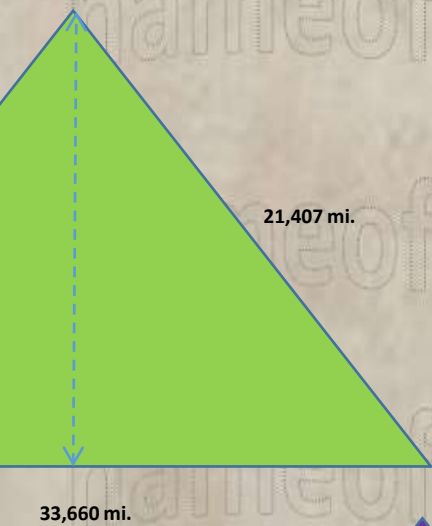

0 Miles  
5

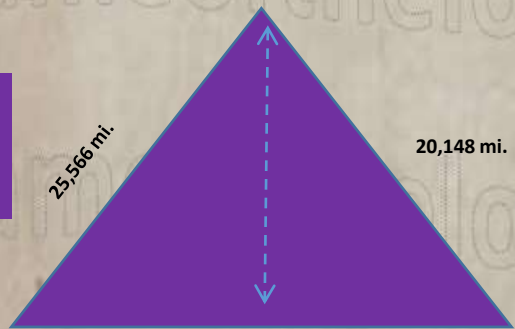

Jerusalem = 31,504  
Giza\* 345,733

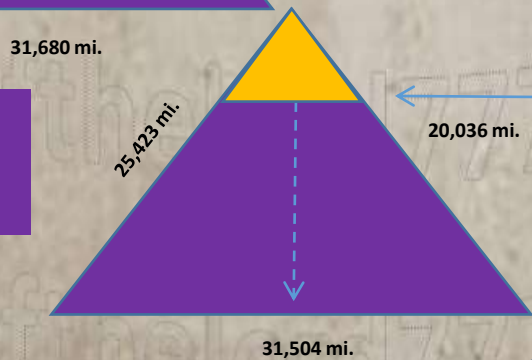

ment7= God's New Jerusalem =  
Firmament= Giza\* 228,158



(God Repeats for emphasis) of the apothem size repeats the 1212. 12 disciples, 12 foundations, 12 gems, etc of Rev. 21 New Jerusalem description. The base size in Furlongs is 7920000 which also verifies the discovery by being 10,000 times the height of the Flat earth firmament of 7920. The Furlongs verified by Gods numbers for New Jerusalem ie 1440 fractal of 144,000. Only Black Cube Luciferian people will argue that New Jerusalem is a cube or un studied in the Giza Pyramid. Isa. 19:19.

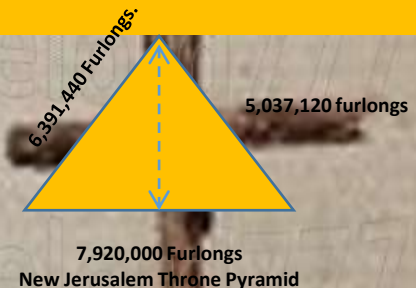
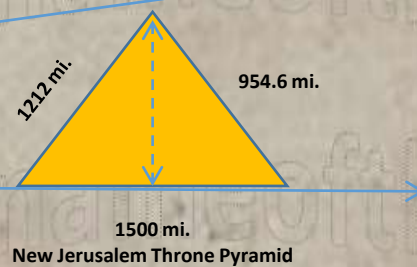



God's Firmament = 88022 = Great White Throne of Judgment Rev. 20:11

Jesus Abode Firmament = 31,680 mi

New Jerusalem Firmament = 31,504 = Rev. 21:2

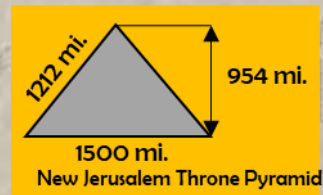

Sun and Moon Analemma = Aleph and Tav Name of Lord

- Sun and Moon Horizontal Speeds moving in the firmament**
- 778 mph at the Tropic of Cancer (BNM=Good News)
  - 1037 mph at the Equator (BNM=Falling Away)
  - 1296 mph at the Tropic of Capricorn (BNM= New Jerusalem)

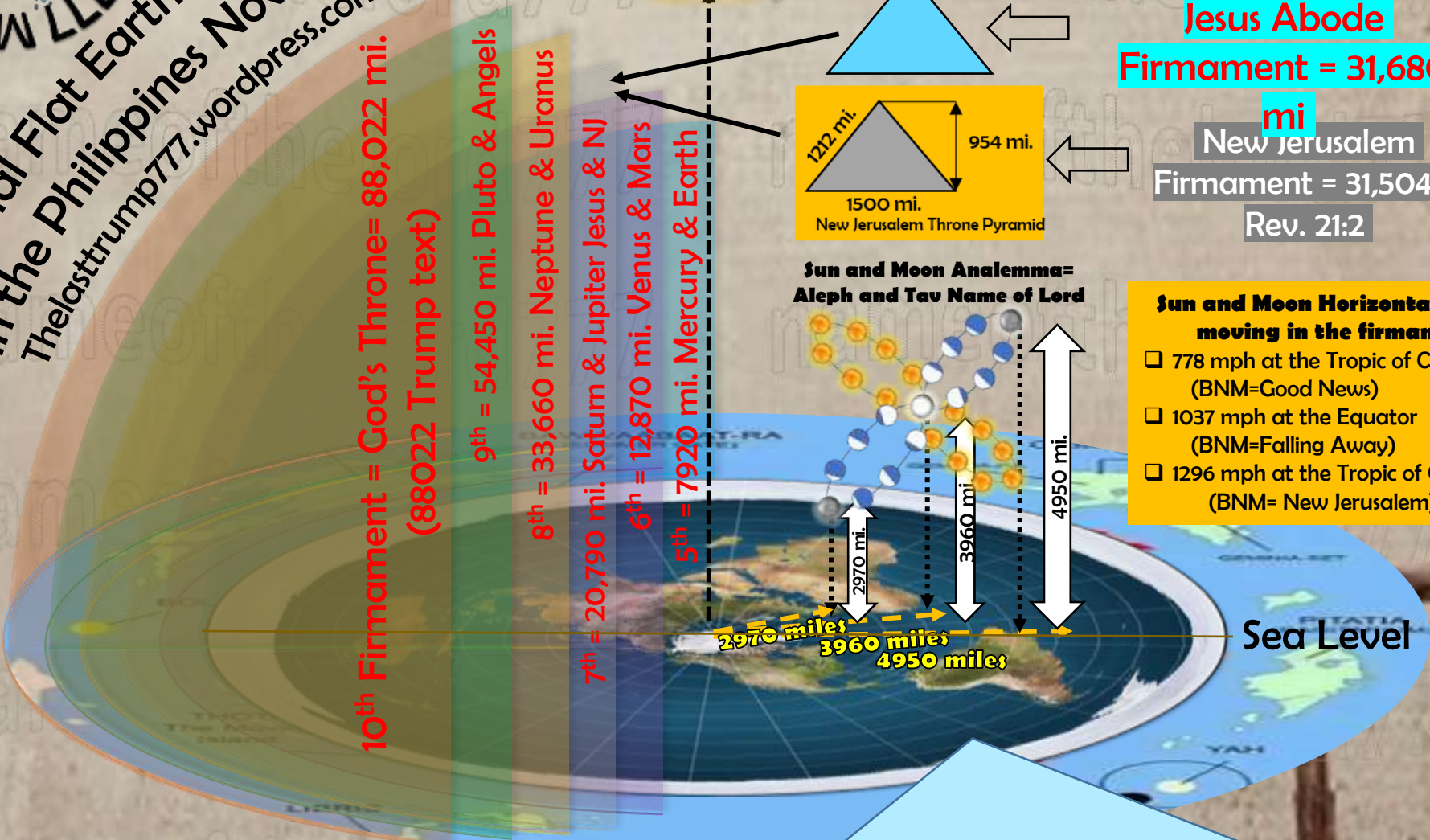

When Traveling Down the Firmament Sun, with a complete cycle= 365.24 days, the Sun changes 10.84 miles in elevation as they both travel a Fibonacci curve crisscrossing down the firmament creating the 14 phases of the moon and the Moon changes elevation and increases by 67.05 miles a day with a complete cycle=59.06 days.  
 Daily snapshots create the Analemma. Lastdays.....

7th Firmament this  
is the Home of  
many important  
issues



Throne of  
God

I.e. the New  
Jerusalem  
= 31504, Jesus Abode  
= 31680 and the  
Planets Jupiter and  
Saturn  
share this  
firmament.

**F7**

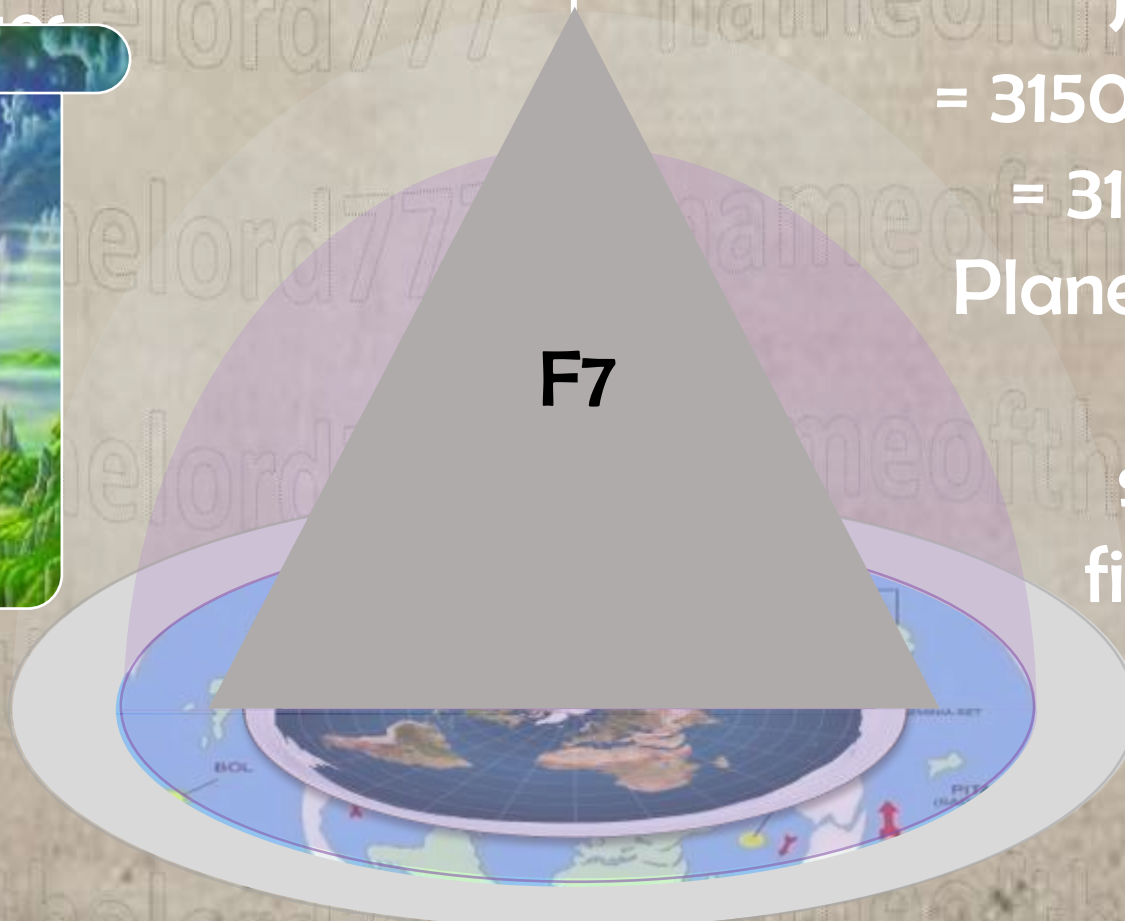

**F7** = 7<sup>th</sup> Firmament = 20790 mi. radius 8<sup>th</sup> AEON 36,288

This is New Jerusalem  
Firmament



← Throne of  
God

31504 pyramid  
between the 7th  
firmament and  
the 8<sup>th</sup>  
firmament. Right  
below Jesus Home  
at 31680.

**F7.832**  
**New Jerusalem**



**F7.832** = 7.832nd Firmament = 31504  
mi. radius

8<sup>th</sup> AEON 36,288

This is Jesus Abode  
Firmament



Throne of  
God

31680  
pyramid  
between the  
7th firmament  
and the 8th  
firmament.

**F7.846**  
**Jesus Abode**



**F7.846** = 7.846<sup>th</sup> Firmament = 31680 mi.  
radius

8<sup>th</sup> AEON 36,288

Locating The Jesus Pyramid at 31,680 mi. height at Firmament level 7.846 and New Jerusalem at 31,504 mi. height at Firmament 7.832

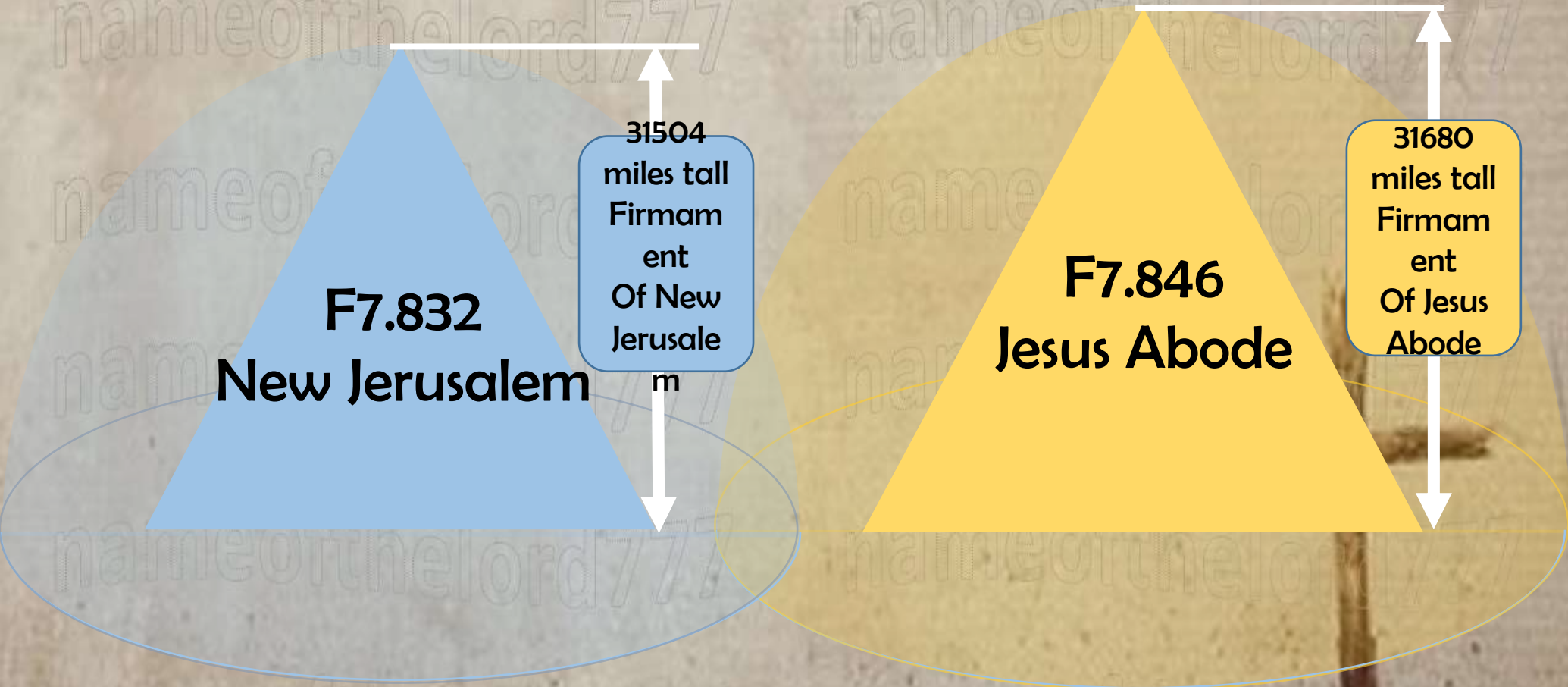

# New Jerusalem at 31,504 mi. height at Firmament 7.832

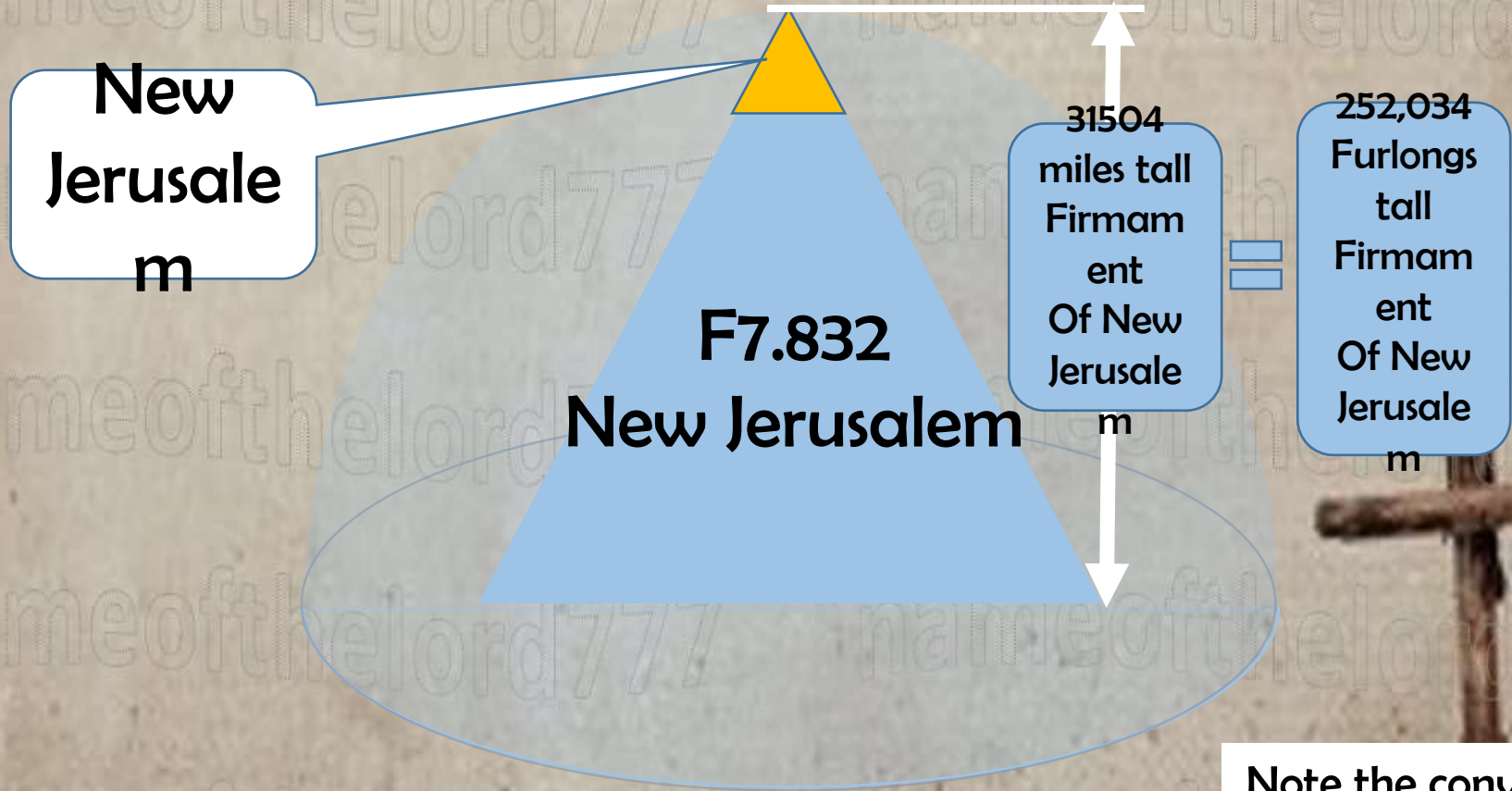

**Note the conversion:  
1 Furlong = 660 feet  
and a mile has 5280 feet.**





**Luke 8:17 For nothing is secret, that shall not be made manifest; neither any thing hid, that shall not be known and come abroad.**

## Locating The Jesus Pyramid ie 31680 at firmament level 7.846 in height

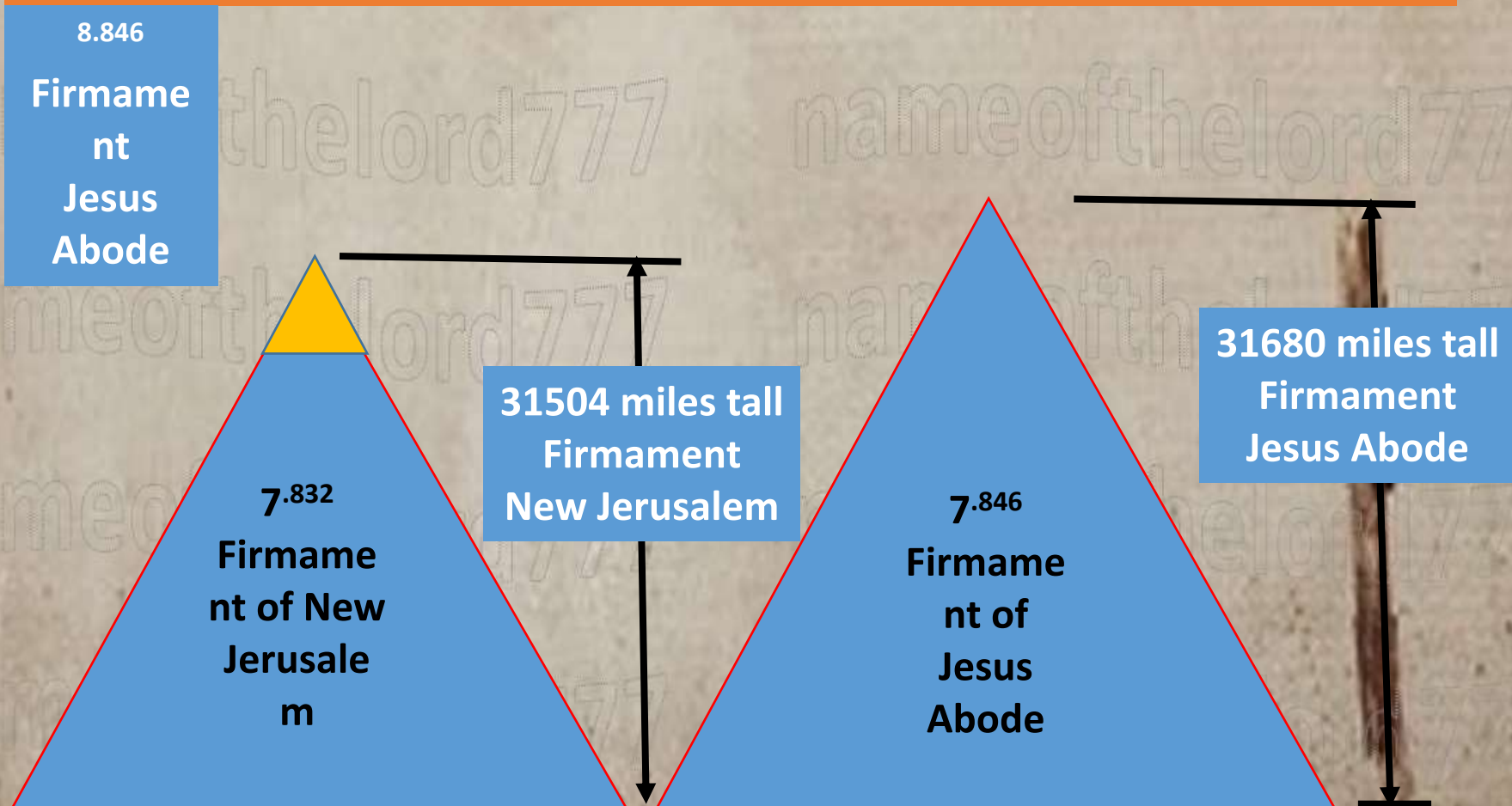



**Luke 8:17 For nothing is secret, that shall not be made manifest; neither any thing hid, that shall not be known and come abroad.**

# Learn the design Procedure for the Giza Pyramid and you can design Gods Flat earth and New Jerusalem and Gods

Aeons	years from creation/Height in feet of Giza Pyramid	Firmaments	enter Miles	Royal Cubit =25.2/12	enter feet or convert to =feet	converting feet to miles	Big Pyramid H=height of Pyramid in miles	Firmament Location of New Jerusalem and Jesus Firmament
Model of Flat earth Giza Pyramid=481.125	481.125		0.091122	229.1071	481.125	0.091122	0.091122	1.000000001
Model of Flat earth Giza Pyramid=480.6637	480.6637		0.091035	228.8875	480.6637	0.091035	0.091035	0.999041207
Model of Flat earth Giza Pyramid= 475.5	475.5		0.090057	226.4286	475.5	0.090057	0.090057	0.988308653
1st Aeon	0	1st Firmament	7920.12	2489181	5227279	990.015	990.015	10864.70087
2nd Aeon	5184	1st Firmament	7920.12	2489181	5227279	990.015	990.015	10864.70087
3rd Aeon	10368	2nd Firmament	15840.24	4978361	10454558	1980.03	1980.03	21729.40174
4th Aeon	15552	3rd Firmament	23760.36	7467542	15681838	2970.045	2970.045	32594.1026
5th Aeon	20736	4th Firmament	39600.6	12445903	26136396	4950.075	4950.075	54323.50434
6th Aeon	25920	5th Firmament	63360.96	19913445	41818234	7920.12	7920.12	86917.60695
7th Aeon	31104	6th Firmament	102961.6	32359347	67954630	12870.2	12870.2	141241.1113
8th Aeon	36288	7th Firmament	166322.5	52272792	1.1E+08	20790.32	20790.32	228158.7182
		New Jerusalem Realm=31504 pyramid between the 7th firmament and the 8th firmament.Right below Jewus Home at 31680.	252032	79210057	1.66E+08	31504	31504	345733.687
		Jesus Realm=31680 pyramid between the 7th firmament and the 8th firmament.Right below Jewus Home at 31680.	253440	79652571	1.67E+08	31680	31680	347665.1601
9th Aeon	41472	8th Firmament	269284.1	84632139	1.78E+08	33660.51	33660.51	369399.8295
10th Aeon	46656	9th Firmament	435606.6	1.37E+08	2.88E+08	54450.83	54450.83	597558.5478
11th Aeon	51840	10th Firmament	704890.7	2.22E+08	4.65E+08	88111.34	88111.34	966958.3773
			435606.6	1.37E+08	2.88E+08	54450.83	481.14	5280.164619
			704890.7	2.22E+08	4.65E+08	88111.34	7920	86916.29003
			3849.12	1209723	2540419	481.14	3960	43458.14502
			63360	19913143	41817600	7920	2970	32593.60876
			31680	9956571	20908800	3960	4950	54322.68127
			23760	7467429	15681600	2970	1980	21729.07251
			39600	12445714	26136000	4950	990	10864.53625



**Luke 8:17 For nothing is secret, that shall not be made manifest; neither any thing hid, that shall not be known and come abroad.**

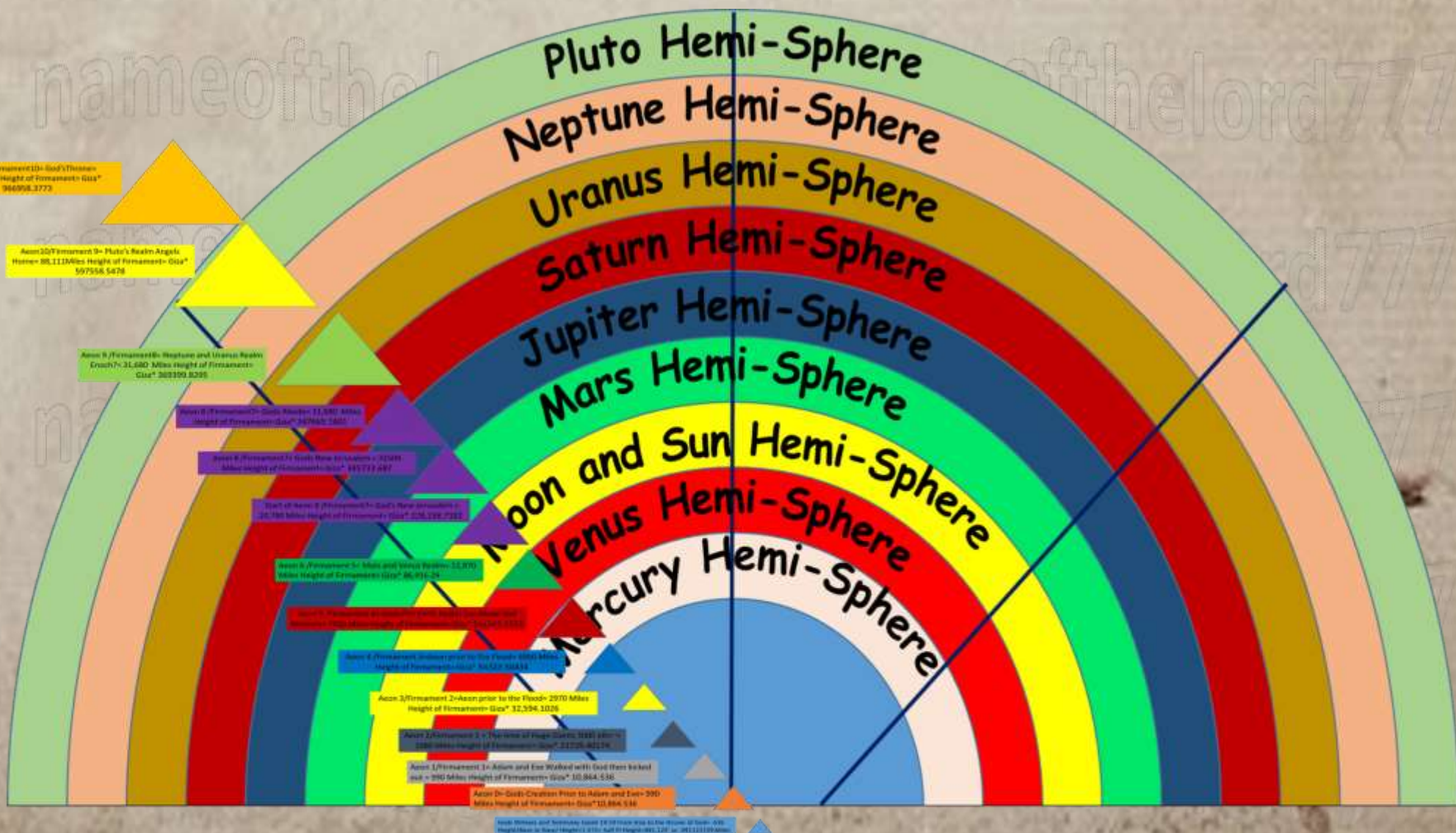

God's Throne and Throne Seat 27,000 Miles - The Throne of God - 490 Miles - Height of Firmament - 110, 844, 516 - 10, 844, 516



**Luke 8:17 For nothing is secret, that shall not be made manifest; neither any thing hid, that shall not be known and come abroad.**

**Learn the design Procedure for the Giza Pyramid and you can design Gods Flat earth and New Jerusalem and Gods Throne**



11.

Introducing  
Universal Design Boss  
for Half Flat Earth  
Model Per Gods Giza  
Pyramid Ratios Analysis

# Nameofthelord777.wordpress.com

## Flat Earth Analysis Relating to Prophecy

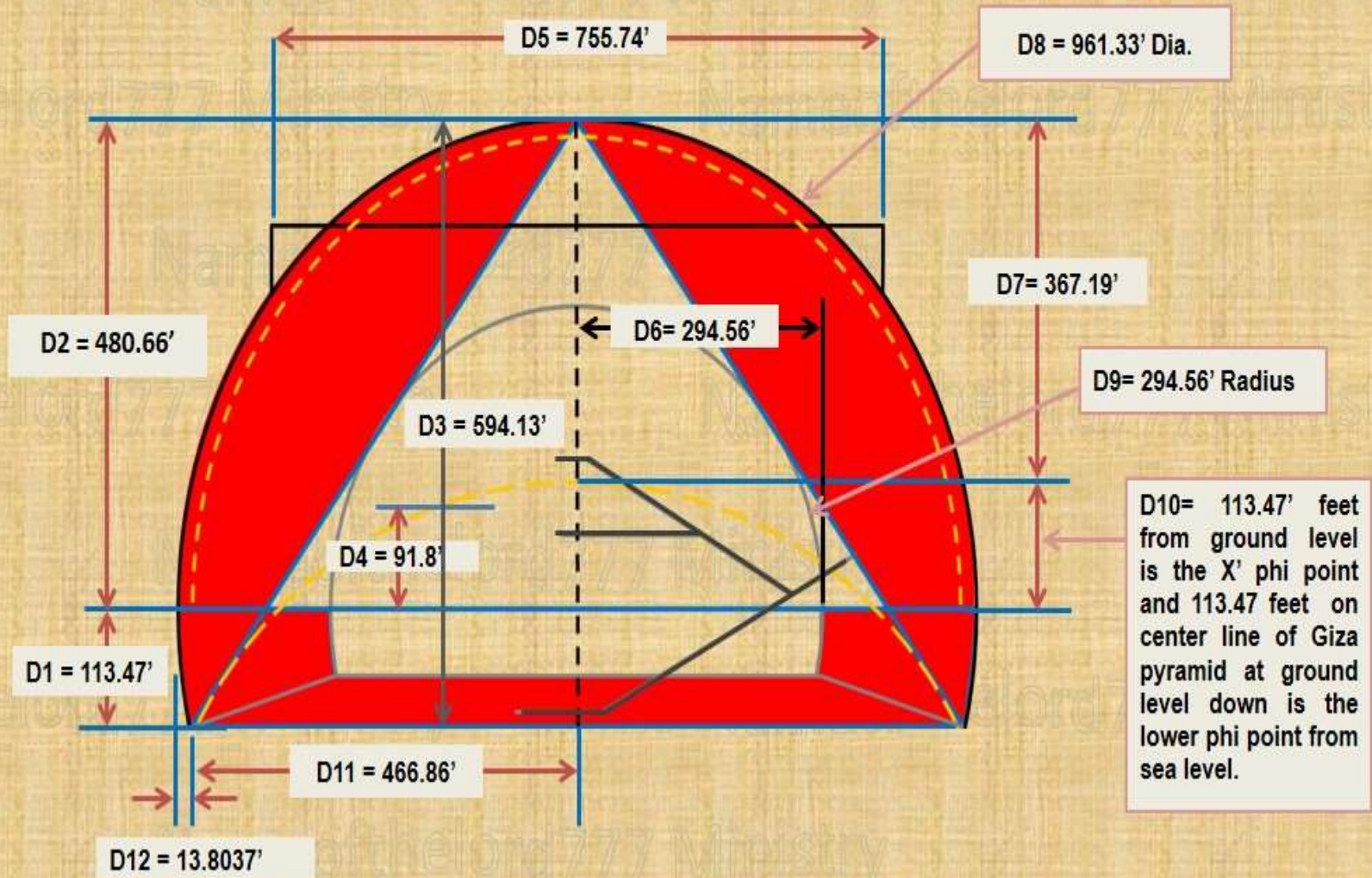



# Nameofthelord777.wordpress.com

## Flat Earth Analysis Relating to Prophecy

### Biblical Numerology Meanings of feet Design Boss Measurements

1260	PATH OF IMMORAL WOMAN LEADS TO HOUSE OF DEAD		2	630	HIDDEN KNOWLEDGE OF GOD	
666	HANDS IN CHAINS		3	222	SON OF A HARLOT	
594	PRECIOUS SACRIFICE		2	297	HOLY TEMPLE	
113	SNATCH AWAY THE SAINTS			[30]	[BLOOD CHILDREN]	
367	1 Chro 29	Isa. 19 v 17	And the land of Judah shall be a terror unto Egypt, every one that maketh mention thereof shall be afraid in himself, because of the counsel of the LORD of hosts, which he hath determined against it.			
368	2 Chro 1	Isa. 19 v 18	In that day shall five cities in the land of Egypt speak the language of Canaan, and swear to the LORD of hosts; one shall be called, The city of destruction.			
367	PLACE OF WORSHIP IS A YOKE			[73]	[BABYLON]	
480	SON OF GOD: ON THE THRONE		2	240	HOLY THINGS LOST	
481	MANY FOES: PUT DOWN		13	37	CHOSEN SERVANT	
755	WORTHLESS IDOLS SENSELESS WARS		5	151	MAN'S POSSESSIONS	
756	CURSED IS HE WHO BREAKS COVENANT		4	189	SWEAR AN OATH	

Confirmation of Gods design is Universal: D3=594 when changed to Years is a Major Eclipse Cycles are (18,36,70,594,666,1260Years) of the Sun and moon as they rotate in the Firmament. When added to the other Major eclipse cycle of 666 years=1260 years and that is Gods Mystery Number of the End Times. Just Like the temple Mount where distances equate to years here the Design Boss circle is



# Nameofthelord777.wordpress.com

## Flat Earth Analysis Relating to Prophecy

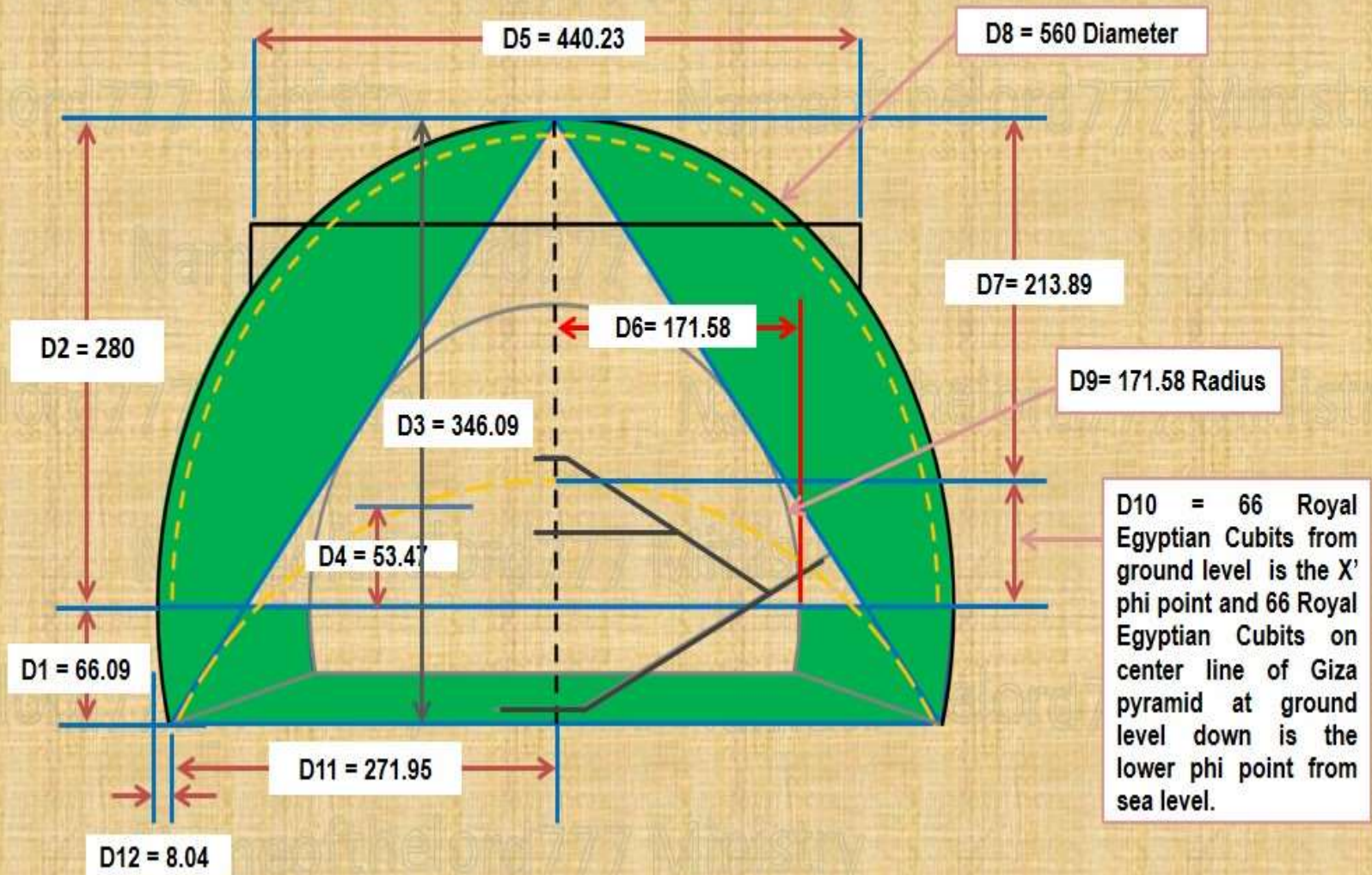





# Nameofthelord777.wordpress.com Flat Earth Analysis Relating to Prophecy

## Biblical Numerology Meanings of Royal Cubit Design Boss Measurements

280	JUSTICE DELAYED	5	56	HARD HEART
66	IDOL WORSHIP	6	11	DARKNESS: Mystery
8	NEW MAN: Eyes, See	2	4	MESSAGE: Hear
53	FAITHFUL WITNESS	[16]	[SACRIFICE]	
440	HOLY LIFE GAINS NOTHING	5	88	RIGHTEOUS AFFLICTED





# Nameofthelord777.wordpress.com

## Flat Earth Analysis Relating to Prophecy

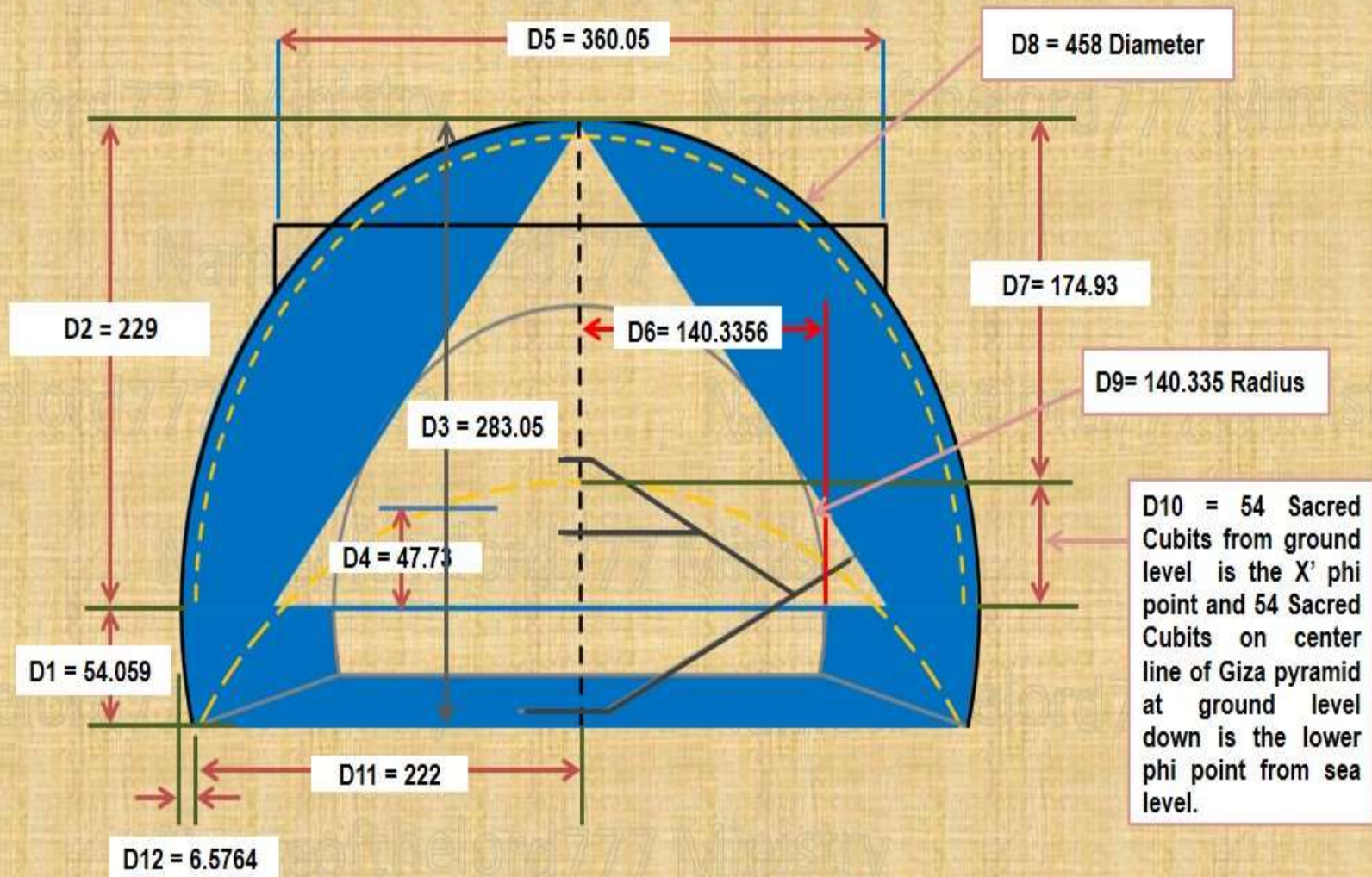



# Nameofthelord777.wordpress.com

## Flat Earth Analysis Relating to Prophecy

### Biblical Numerology Meanings of Sacred Cubit Design Boss Measurements

175	MARRIAGE VIOLATION	5	35	SUFFERING SERVANT
222	SON OF A HARLOT	2	111	FEAR OF THE LORD
229	APOSTATE TRIBE	[50]	[FIRE]	
65	APOSTASY	5	13	REBELLION
360	CHURCH UNIFIED: BOWS TO EARTHLY KING	5	72	EVANGELISTS

nameofthelord777

nameofthelord777

nameofthelord777

nameofthelord777



# Nameofthelord777.wordpress.com

## Flat Earth Analysis Relating to Prophecy

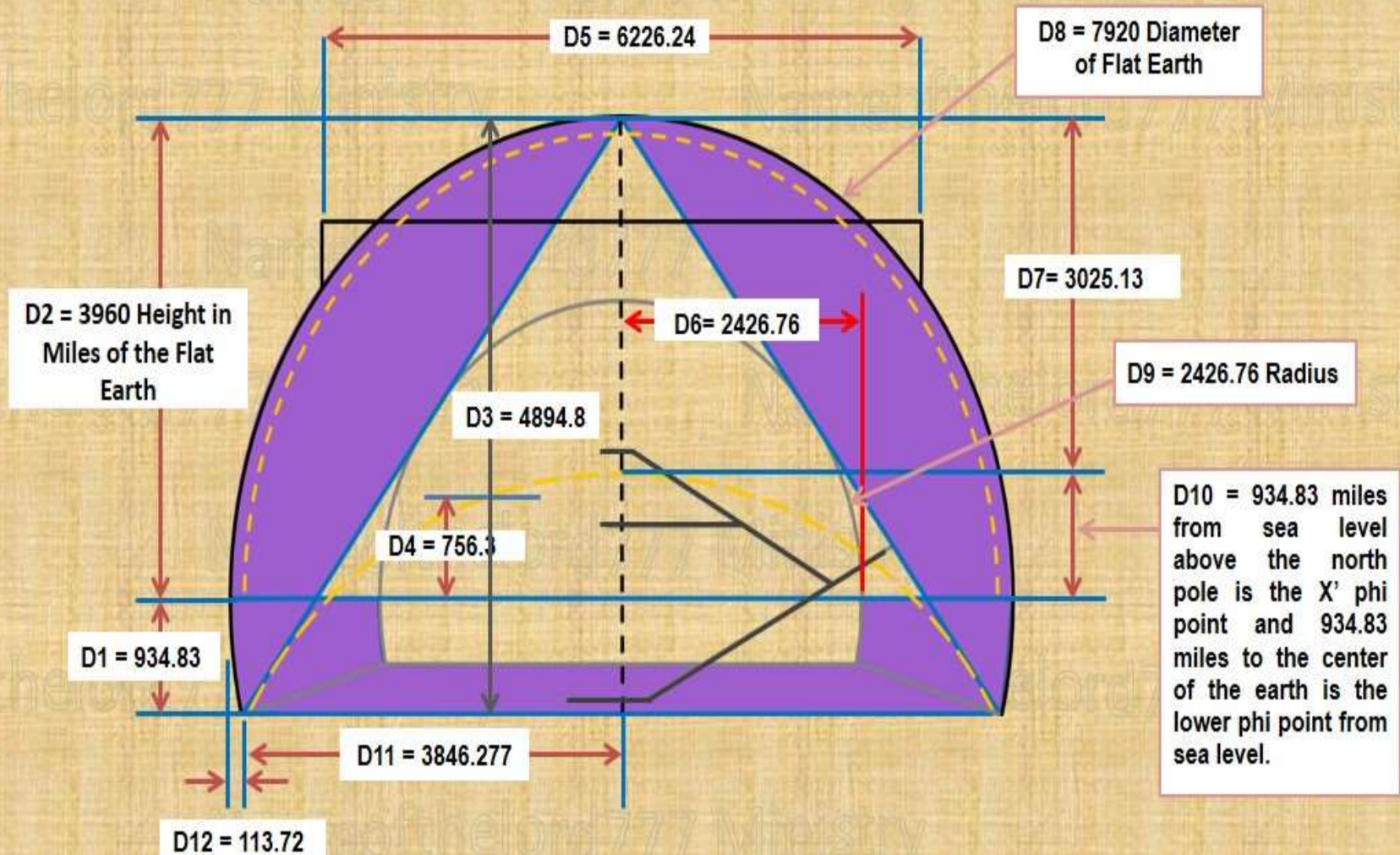

Measures for Flat Earth Boss Units in Miles (Using a 8.23 Ft/Mile conversion factor)



# Nameofthelord777.wordpress.com

## Flat Earth Analysis Relating to Prophecy

### Biblical Numerology Meanings of feet Design Boss Measurements

113	SNATCH AWAY THE SAINTS	[30]	[BLOOD CHILDREN]	
384	HONOR THE LAW OF GOD	2	192	SONS OF ISRAEL CIRCUMCISED
385	LYING PROPHETS MULTIPLY	5	77	THE FALSE PROPHET
396	TEMPLE IS EXALTED	2	198	PRINCE OF DARKNESS
934	SONS OF THE FATHER IN HEAVEN	2	467	SELF-RIGHTEOUS
935	SEEK FIRST HIS KINGDOM AND HIS RIGHTEOUSNESS	5	187	ASCENSION TO HEAVEN
240	HOLY THINGS LOST=2016=240+2016	5	48	FATHER'S BLESSING
241	SAINTS IN PRISON=2017=241+1776	{53	[FAITHFUL WITNESS]	
242	SAINTS GO TO HEAVEN=2018=242+1776	2	121	WATCHMAN
243	SAINTS CROWNED=2019=243+1776	3	81	HOLY ANGELS

Confirmation of Gods design is Universal: D3=594 when changed to Years is a Major Eclipse Cycles are (18,36,70,594,666,1260Years) of the Sun and moon as they rotate in the Firmament. When added to the other Major eclipse cycle of 666 years=1260 years and that is Gods Mystery Number of the End Times. Just Like the temple Mount where distances equate to years here the Design Boss circle is



# The Flat Earth Model!!!

## Data for Flat Earth Layout-7920

		D1	D2	D3	D4	D5	D6	D7	D8	D9	D10	D11	D12
Actual Giza Numbers		113.47	480.66	594.13	91.8	755.74	294.56	367.19	961.33	294.56	113.47	466.86	13.8037
Ratio of Giza Pyramid Multiplier		0.236069	0.999992	1.236062	0.190986	1.572284	0.612819	0.763922884	2.000005	0.612819	0.236069	0.971282	0.028718
Height of Giza Pyramid	480.663700	113.47	480.66	594.13	91.8	755.74	294.56	367.19	961.33	294.56	113.47	466.86	13.8037
Actual Height in with Giza Pi	480.900000	113.5258	480.8963	594.4221	91.84513	756.1115	294.7048	367.370515	961.8026	294.7048	113.5258	467.0895	13.81049
Actual Height in Sacred Cubit	229.000000	54.0599	228.9982	283.0581	43.73578	360.0531	140.3356	174.9383405	458.0012	140.3356	54.0599	222.4236	6.576422
Actual Height in Egyptian Cubit	280.000000	66.09944	279.9978	346.0973	53.47606	440.2396	171.5894	213.8984076	560.0015	171.5894	66.09944	271.959	8.04104
Actual Height in inches with Capstone	5778.000000	1364.009	5777.956	7141.965	1103.517	9084.659	3540.87	4413.946424	11556.03	3540.87	1364.009	5612.067	165.9326
Actual Height with out Capstone	5449.000000	1286.342	5448.958	6735.3	1040.682	8567.377	3339.252	4162.615796	10898.03	3339.252	1286.342	5292.516	156.4844
Height of the Flat Earth Pyramid	7920.000000	1869.67	7919.939	9789.609	1512.609	12452.49	4853.529	6050.269242	15840.04	4853.529	1869.67	7692.553	227.4466
Height of the Flat Earth Pyramid using Giza Pi	7923.9	1870.59	7923.839	9794.429	1513.353	12458.62	4855.919	6053.248542	15847.84	4855.919	1870.59	7696.341	227.5586
Height of the Flat Earth Pyramid using Using the Perfect Cube Measure	7918.8	1869.387	7918.739	9788.126	1512.379	12450.61	4852.794	6049.352535	15837.64	4852.794	1869.387	7691.388	227.4121



# The Flat Earth Model!!!

## Data for Flat Earth Layout-7920

THE "STONE MESSAGE"  
 CALLED A "CONSTRUCTION BOSS", IN THE ANTECHAMBER  
 ITS SHAPE DEFINES THE GEOMETRY OF THE GREAT PYRAMID

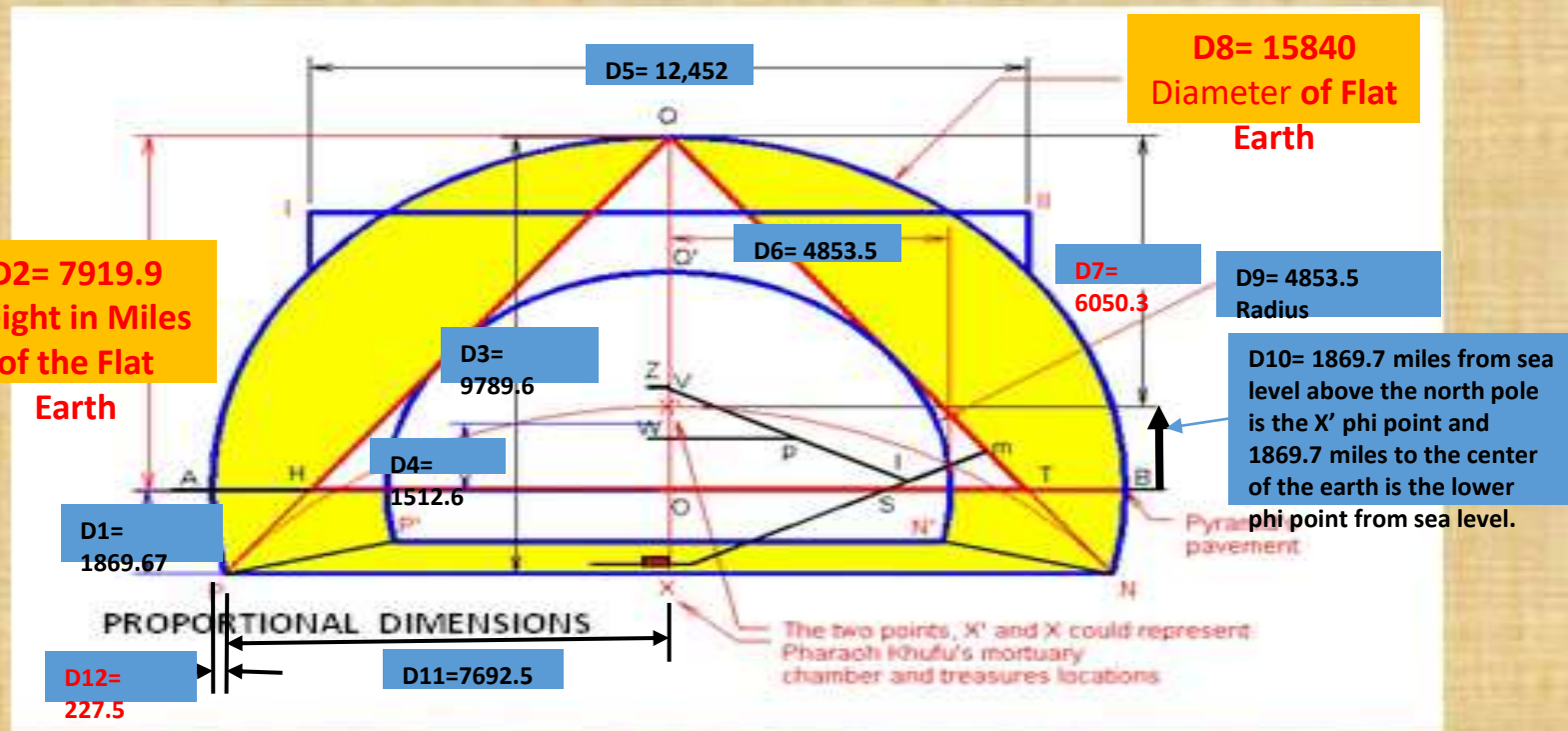

DECODING THE STONE MESSAGE



# FlatearthisGodsFootstool.com Flat Earth Analysis Relating to Prophecy

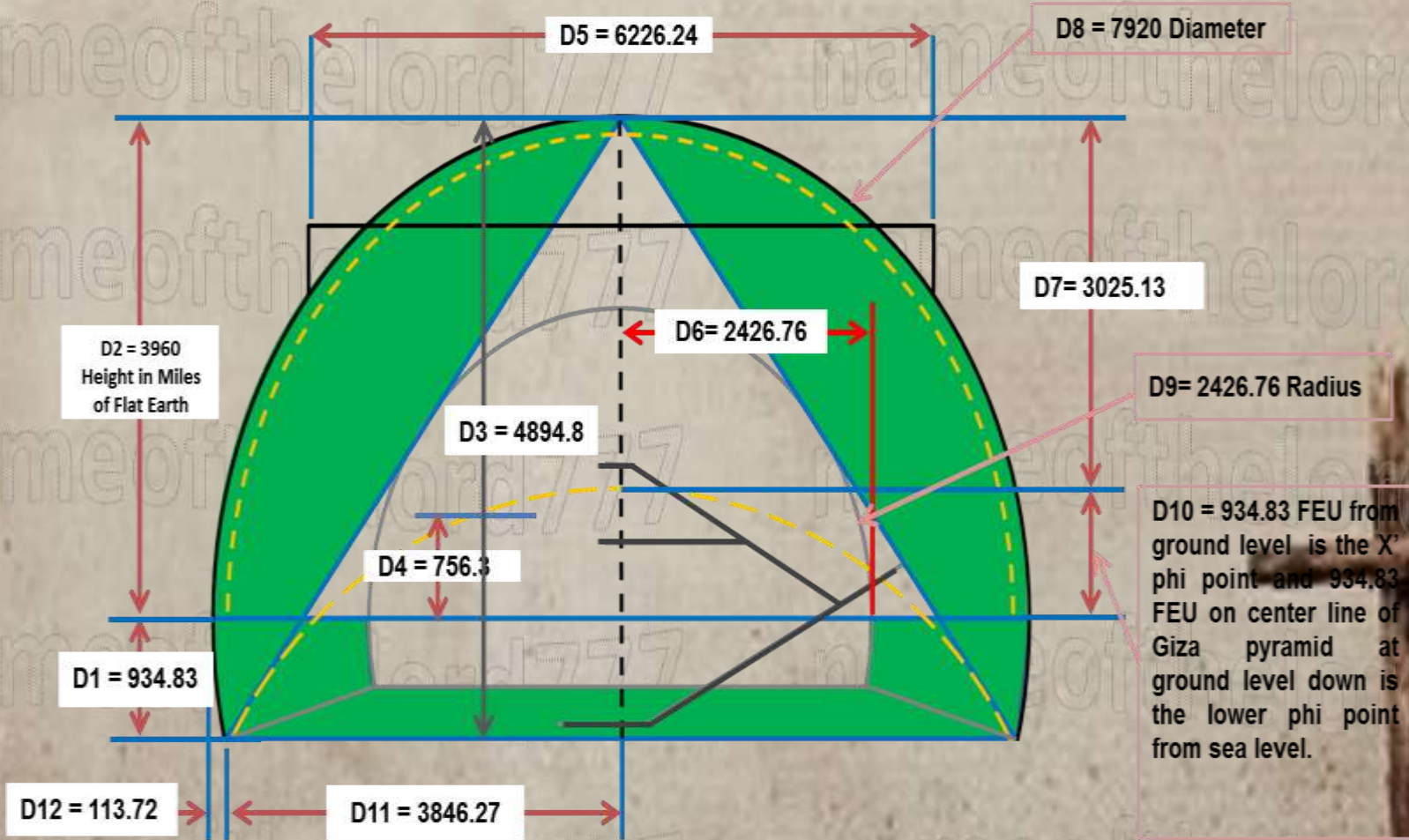

## Half Flat Earth Measurements





# Nameofthelord777.wordpress.com

## Flat Earth Analysis Relating to Prophecy

### Biblical Numerology Meanings of Flat Earth Measurements

113	SNATCH AWAY THE SAINTS	[30]	[BLOOD CHILDREN]
384	HONOR THE LAW OF GOD	2	192 SONS OF ISRAEL CIRCUMCISED
385	LYING PROPHETS MULTIPLY	5	77 THE FALSE PROPHET
396	TEMPLE IS EXALTED	2	198 PRINCE OF DARKNESS
934	SONS OF THE FATHER IN HEAVEN	2	467 SELF-RIGHTEOUS
935	SEEK FIRST HIS KINGDOM AND HIS RIGHTEOUSNESS	5	187 ASCENSION TO HEAVEN
240	HOLY THINGS LOST=2016=240+2016	5	48 FATHER'S BLESSING
241	SAINTS IN PRISON=2017=241+1776	{53	[FAITHFUL WITNESS]
242	SAINTS GO TO HEAVEN=2018=242+1776	2	121 WATCHMAN
243	SAINTS CROWNED=2019=243+1776	3	81 HOLY ANGELS

Confirmation of Gods design is Universal: D3=594 when changed to Years is a Major Eclipse Cycles are (18,36,70,594,666,1260Years) of the Sun and moon as they rotate in the Firmament. When added to the other Major eclipse cycle of 666 years=1260 years and that is Gods Mystery Number of the End Times. Just Like the temple Mount where distances equate to years here the Design Boss circle is



# Name of the Lord 777 Ministry Humbly Presents for Your Edification the Rediscovered and Revealed Information Promised in the Last days. Flat Earth Model Designed by God!!!

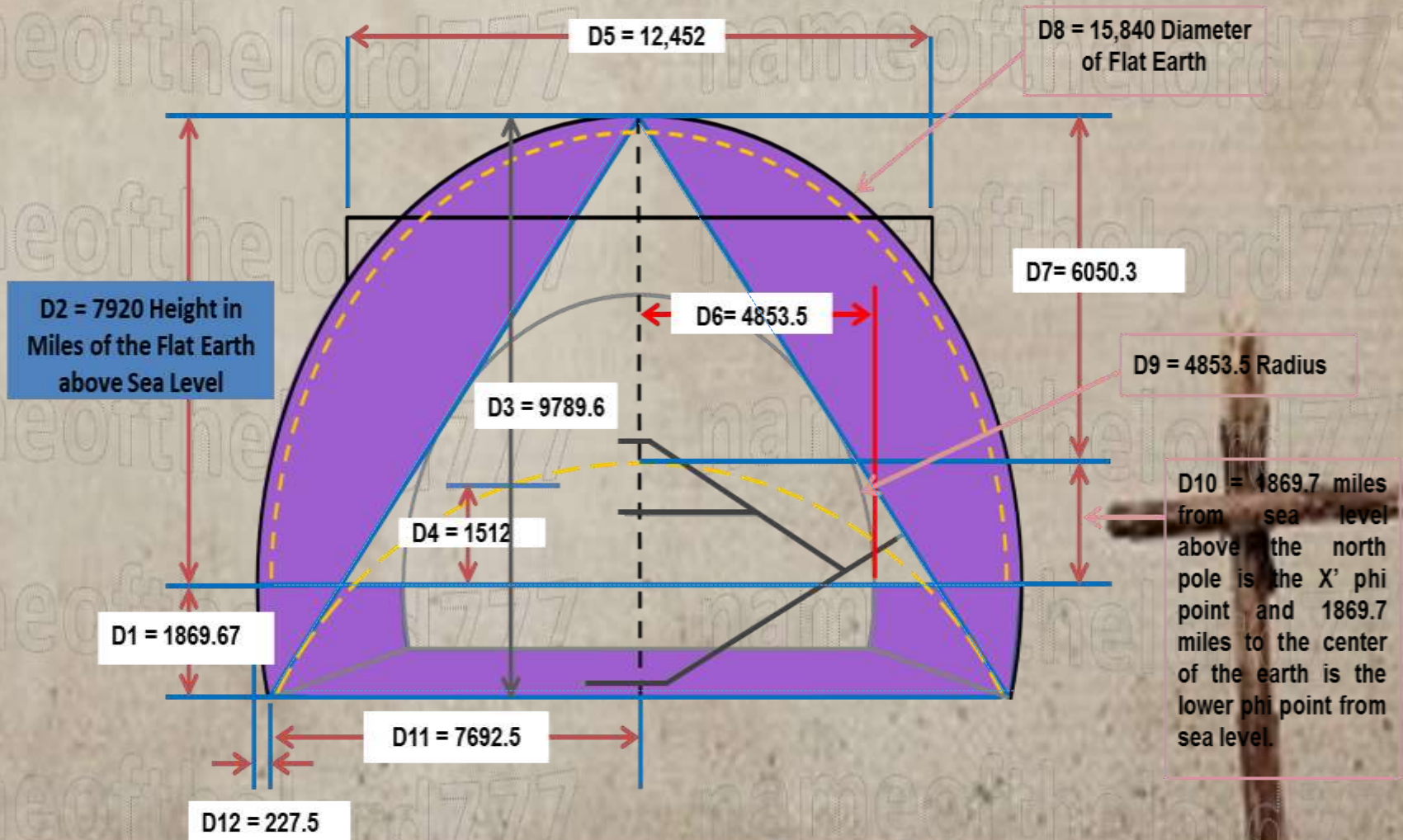

**Data for Flat Earth Design Boss Measurements**



# Nameofthelord777.wordpress.com

## Flat Earth Analysis Relating to Prophecy

### Biblical Numerology Meanings of Flat Earth Measurements

227	BLINDNESS TO BETRAYAL	[49]	[TIME OF THE END]
228	PRIEST FOR HIRE	2	114 OLD COVENANT RESTORED
979	IF THE ROOT IS HOLY: THE BRANCH IS HOLY	11	89 SON OF DAVID
980	MEN HEAL BLINDLY FOLLOW LEADERS WHO CAN'T	2	490 EVERY BOASTFUL MOUTH SHUT
1210	PHARAOH LOVES YOUNG BOYS: SHAVEN IN GOWNS	2	605 CITY DOOMED
1583	WITH ONLY ONE SWORD EVERY ENEMY DEFEATED	Prime	{250 [DEVOURING FIRE]}
1584	KING'S LAND IS LOST	11	144 JESUS IS LORD
1792	BE PATIENT BROTHERS UNTIL THE LORD'S COMING	2	896 SHEEP EATEN BY THEIR SHEPHERDS
791	WARRIORS FLEE, STUMBLE, FALL	7	113 RAPTURE OF SAINTS
792	SWORD CUTS OFF ALL FLESH	2	396 TEMPLE IS EXALTED
793	TERROR, PIT, SNARE AWAIT YOU O MOAB	13	61 KING OF JEWS: MESSIAH
792	Jer 47	Isa. 40 v 26	Lift up your eyes on high, and behold who hath created these things, that bringeth out their host by number; he calleth them all by names by the greatness of his might, for that he is strong in power; not one faileth.
1511	ASK THE DEVIL TO PRAY TO GOD FOR YOU	Prime	{240 [HOLY THINGS LOST]}
1512	ZEAL FOR MY FATHER'S HOUSE WILL CONSUME ME	2	756 CURSED IS HE WHO BREAKS COVENANT
1870		5	374 PROMISE TO PUNISH SIN
1871		Prime	[286] [CONFESS YOUR SINS!]

Confirmation of Gods design is Universal: D3=594 when changed to Years is a Major Eclipse Cycles are (18,36,70,594,666,1260Years) of the Sun and moon as they rotate in the Firmament. When added to the other Major eclipse cycle of 666 years=1260 years and that is Gods Mystery Number of the End Times. Just Like the temple Mount where distances equate to years here the Design Boss circle is



# Name of the Lord 777 Ministry Humbly Presents for Your Edification the Rediscovered and Revealed Information Promised in the Last days. Flat Earth Model Designed by God!!!

**All Flat Earth  
Units in Red  
Color.  
Half Flat Earth  
Units in Black**

**D2 = 7920 Height in  
Miles of the Flat Earth  
above Sea Level**

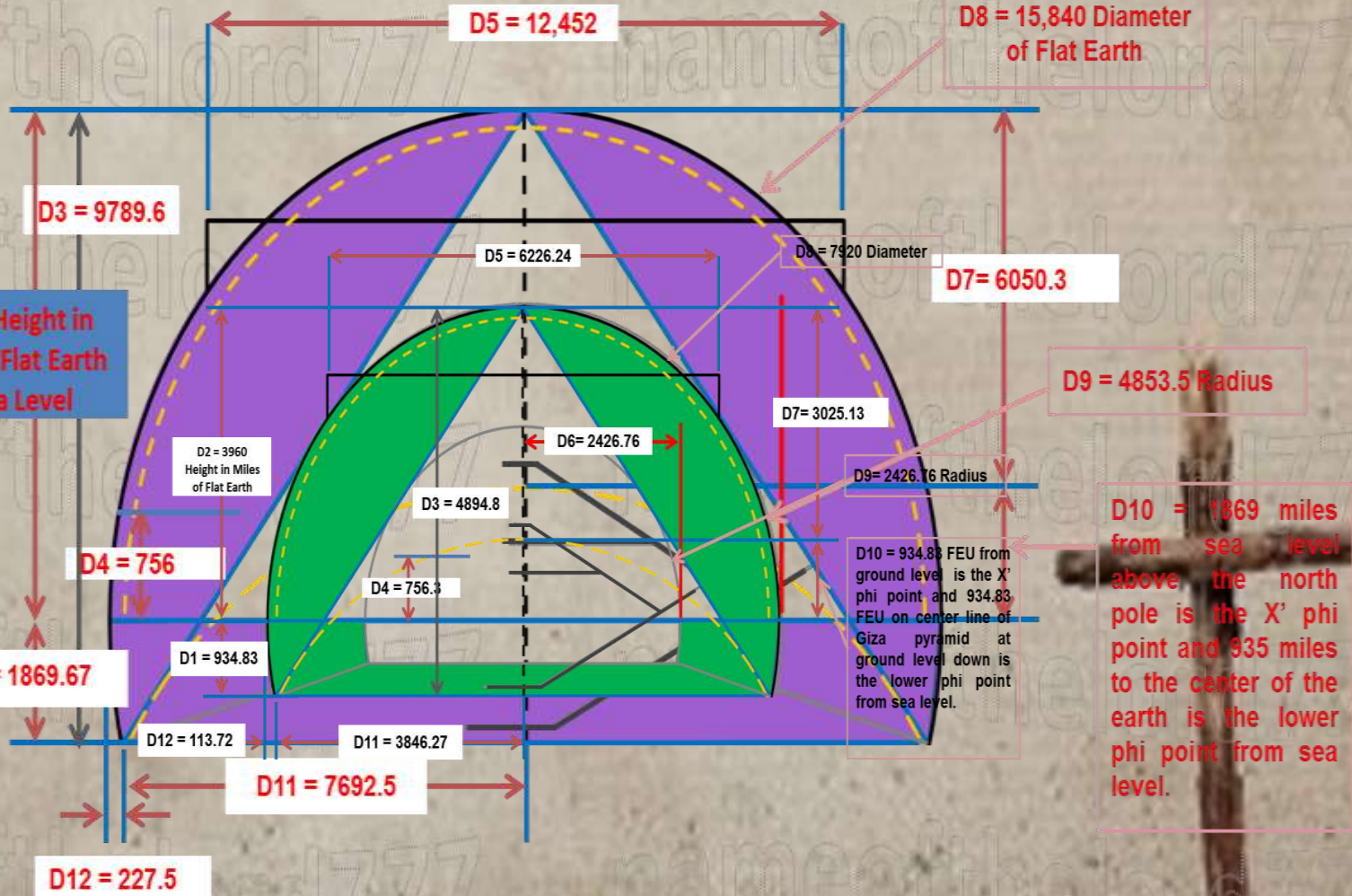



# Name of the Lord 777 Ministry

## Humbly Presents for Your Edification the Rediscovered and Revealed Information Promised in the Last days. Flat Earth Model Designed by God!!!

All Flat Earth Units in Red Color.  
Half Flat Earth Units in Black

D2 = 7920 Height in Miles of the Flat Earth above Sea Level

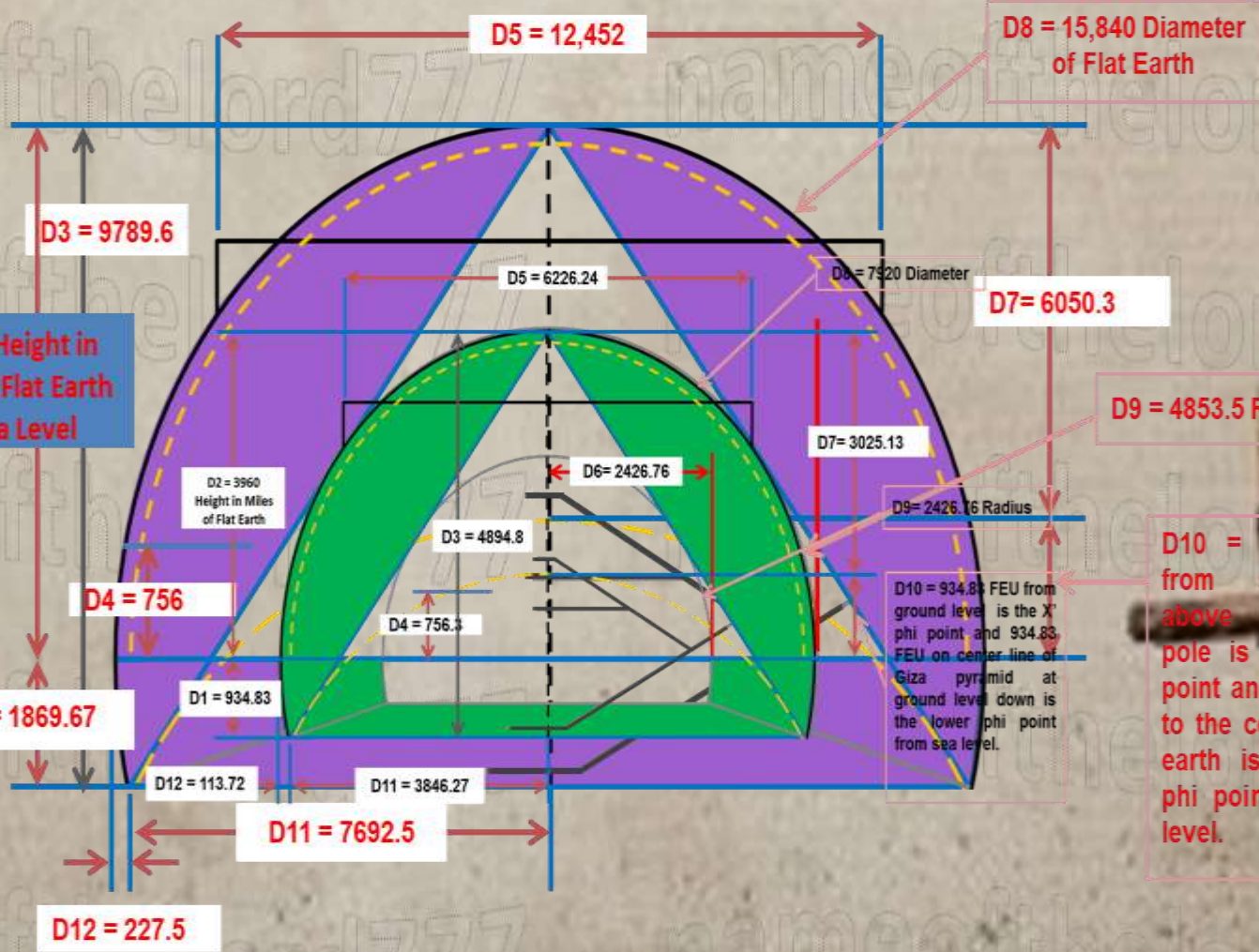

D8 = 15,840 Diameter of Flat Earth

D7 = 6050.3

D9 = 4853.5 Radius

D10 = 1869 miles from sea level above the north pole is the X' phi point and 934.83 FEU from ground level is the X' phi point and 934.83 FEU on center line of Giza pyramid at ground level down is the lower phi point from sea level.

D12 = 227.5

D11 = 7692.5

D1 = 1869.67

D4 = 756

D3 = 9789.6

D5 = 12,452

D5 = 6226.24

D8 = 7920 Diameter

D7 = 3025.13

D10 = 934.83 FEU from ground level is the X' phi point and 934.83 FEU on center line of Giza pyramid at ground level down is the lower phi point from sea level.

D9 = 2426.16 Radius

D6 = 2426.76

D3 = 4894.8

D4 = 756.3

D1 = 934.83

D12 = 113.72

D11 = 3846.27

D2 = 3960 Height in Miles of Flat Earth



# Name of the Lord 777 Ministry

## Humbly Presents for Your Edification the Rediscovered and Revealed Information Promised in the Last days. Flat Earth Model Designed by God!!!

All Flat Earth Units in Red Color.  
Half Flat Earth Units in Black

D2 = 7920 Height in Miles of the Flat Earth above Sea Level

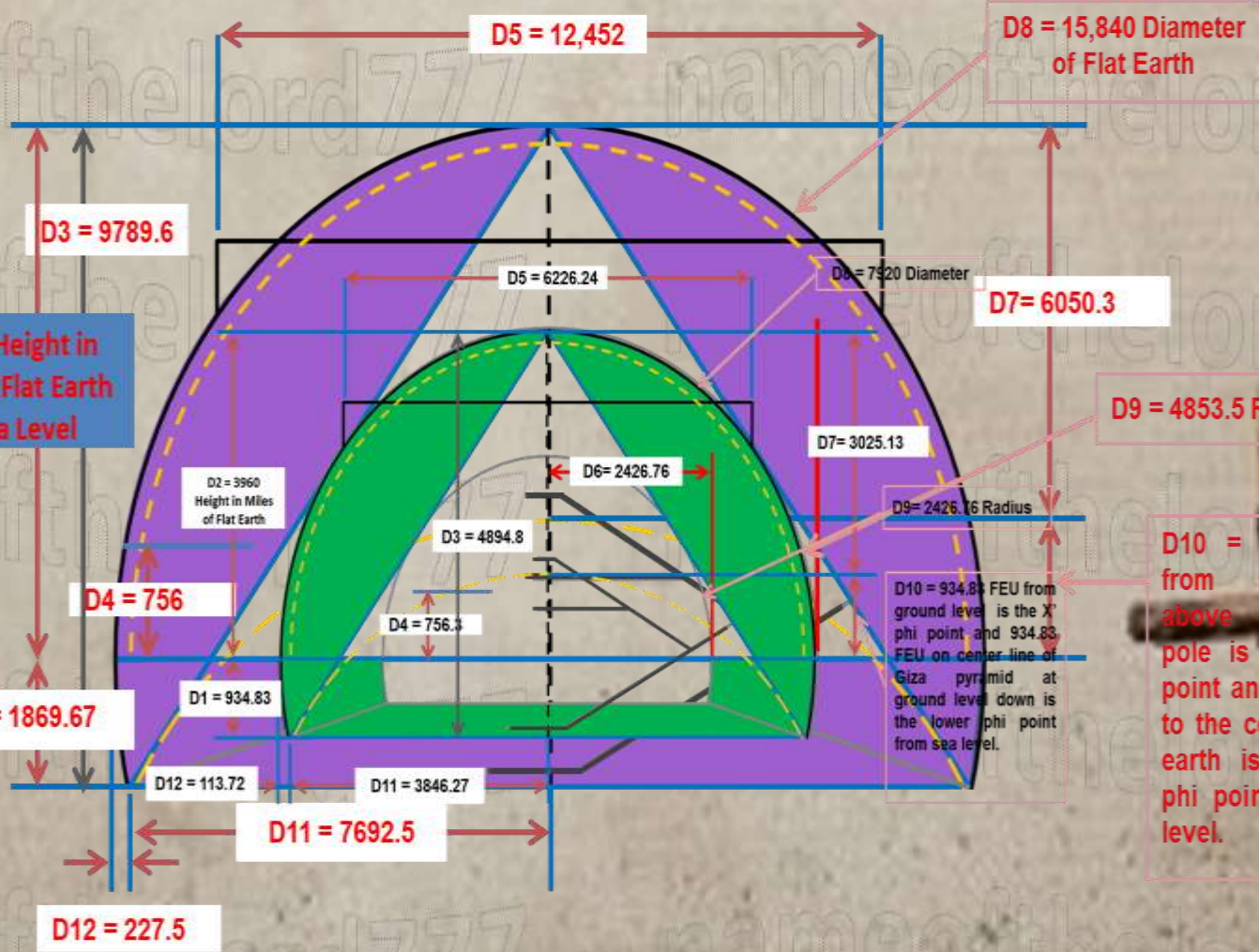

D8 = 15,840 Diameter of Flat Earth

D7 = 6050.3

D9 = 4853.5 Radius

D10 = 1869 miles from sea level above the north pole is the X' phi point and 934.83 FEU on center line of Giza pyramid at ground level down is the lower phi point from sea level.

D10 = 934.83 FEU from ground level is the X' phi point and 934.83 FEU on center line of Giza pyramid at ground level down is the lower phi point from sea level.

D12 = 227.5

D11 = 7692.5

D1 = 1869.67

D4 = 756

D2 = 3960 Height in Miles of Flat Earth

D5 = 12,452

D5 = 6226.24

D8 = 7920 Diameter

D7 = 3025.13

D6 = 2426.76

D9 = 2426.16 Radius

D3 = 4894.8

D4 = 756.3

D1 = 934.83

D12 = 113.72

D11 = 3846.27



# Name of the Lord 777 Ministry Humbly Presents for Your Edification the Rediscovered and Revealed Information Promised in the Last days. Flat Earth Model Designed by God!!!

All Flat Earth Units  
in Red Color.  
Half Flat Earth Units  
in Black

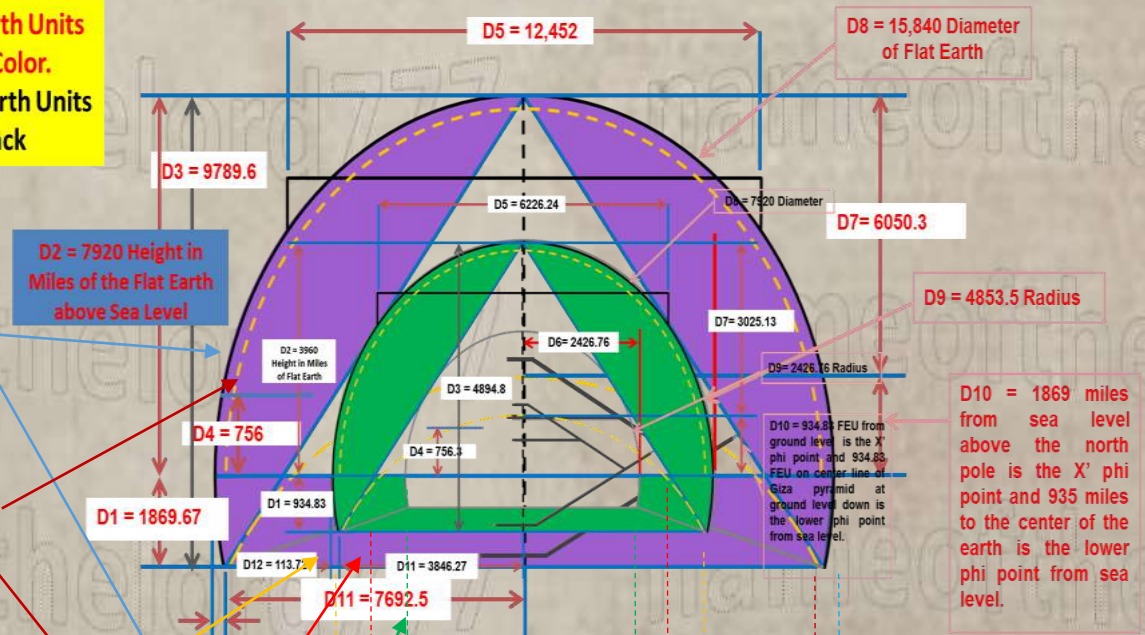

Outer Firmament  
Firmament

Inner Firmament  
Firmament  
Arctica 2 Mile High

Tropic of Capricorn  
perimeter of the  
Sun's Helical Orbit in  
Firmament

Equator  
Position of the Sun at the  
Spring and Fall Equinoxes  
of the Sun's Helical Orbit

A6= North Pole or Inner Pole  
the Entrance to the  
Underworld. IE Northern  
Lights



# Name of the Lord 777 Ministry Humbly Presents for Your Edification the Rediscovered and Revealed Information Promised in the Last days. Flat Earth Model Designed by God!!!

**Plan View of Flat Earth System as Designed By God Elohim**

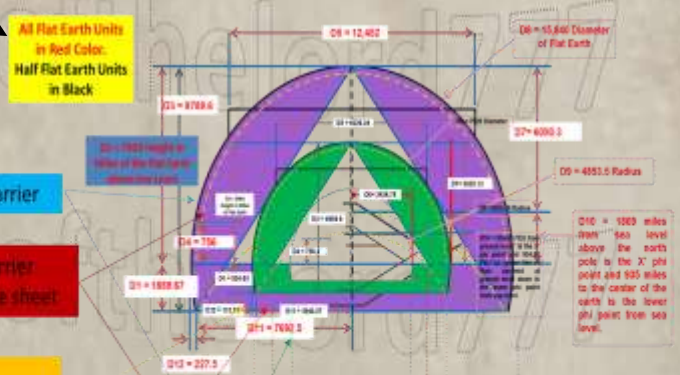

- A1= Outer Firmament Barrier**
- A2= Inner Firmament Barrier**  
Antarctica 2 Mile High Ice sheet
- A3= Tropic of Capricorn**  
Outer perimeter of the Sun's Helical Orbit in the Firmament
- A4= Equator**  
Location of the Sun at the Spring and Fall Equinoxes in the Sun's Helical Orbit in the Firmament
- A5= Tropic of Cancer**  
Location of the Sun at the Summer Solstice for Inner Equator Lands in the Sun's Helical Orbit in the Firmament

**A6= North Pole or Inner Pole**  
the Entrance to the Underworld. IE Northern Lights

**Isometric View of Flat Earth System as Designed By God Elohim**

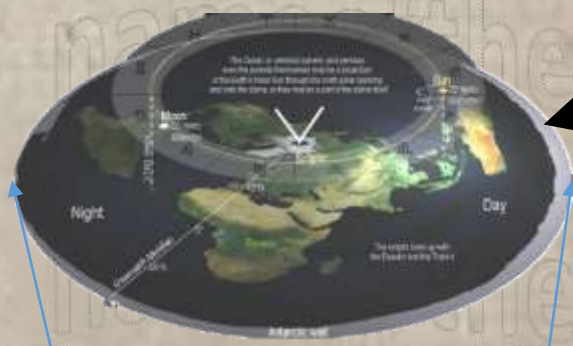

**Top View of Flat Earth System as Designed By God Elohim**



The Diameter through the North Pole from Antarctica Ice wall and Across=15,828 Miles

The Diameter through the North Pole of the Equator on the Flat Earth Model =7,914 Miles



Why are the Illuminati and  
Masons and Jesuits giving  
you the Mocking Tongue???





Luke 8:17 For nothing is secret, that shall not be made manifest; neither any thing hid, that shall not be known and come abroad.

# Hollywood is not just for sinners anymore they are giving Helpful hints to Saints in these last days: Mocking tongue of Masons





Luke 8:17 For nothing is secret, that shall not be made manifest; neither any thing hid, that shall not be known and come abroad.

# Hollywood is not just for sinners anymore they are giving Helpful hints to Saints in these last days: Mocking tongue of Masons

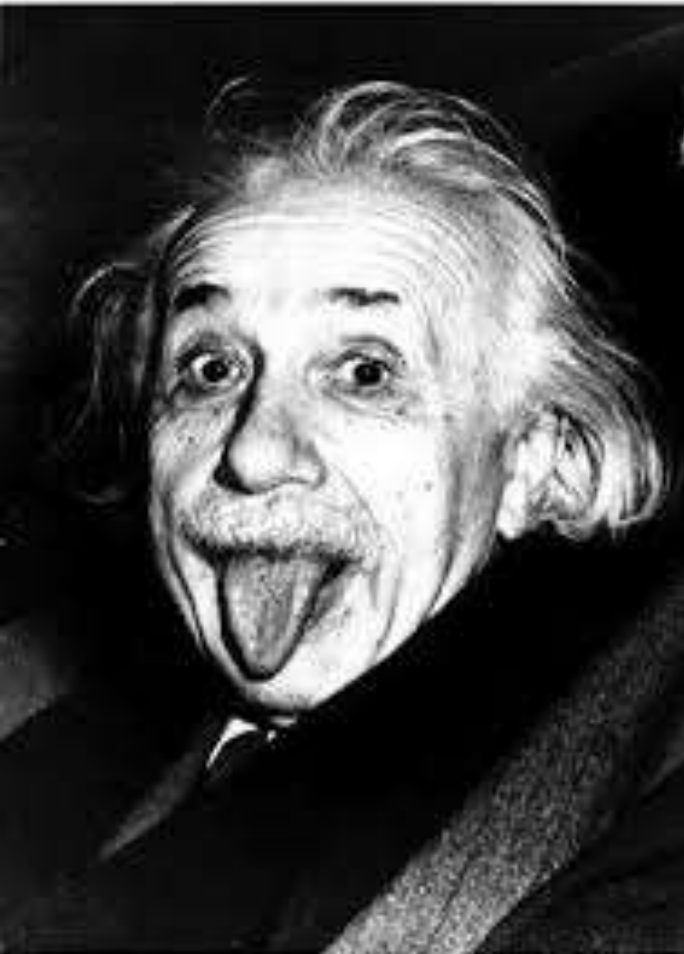

Thanks to Nikola Tesla's wisdom from God that revealed His Great Power.

Thank you Mr. Tesla for explaining Electromagnetic Differential Potential of Various Items like the earth and all objects with Mass. If you want to call that Gravity you are lying about something. Oh Ya the Globe Earth!!! Everything is Electricity!!! Did we mention they had wireless lights in the Giza pyramid check out the Hieroglyphs...

I don't care that they stole my idea  
I care that they don't have any of their own

- Nikola Tesla

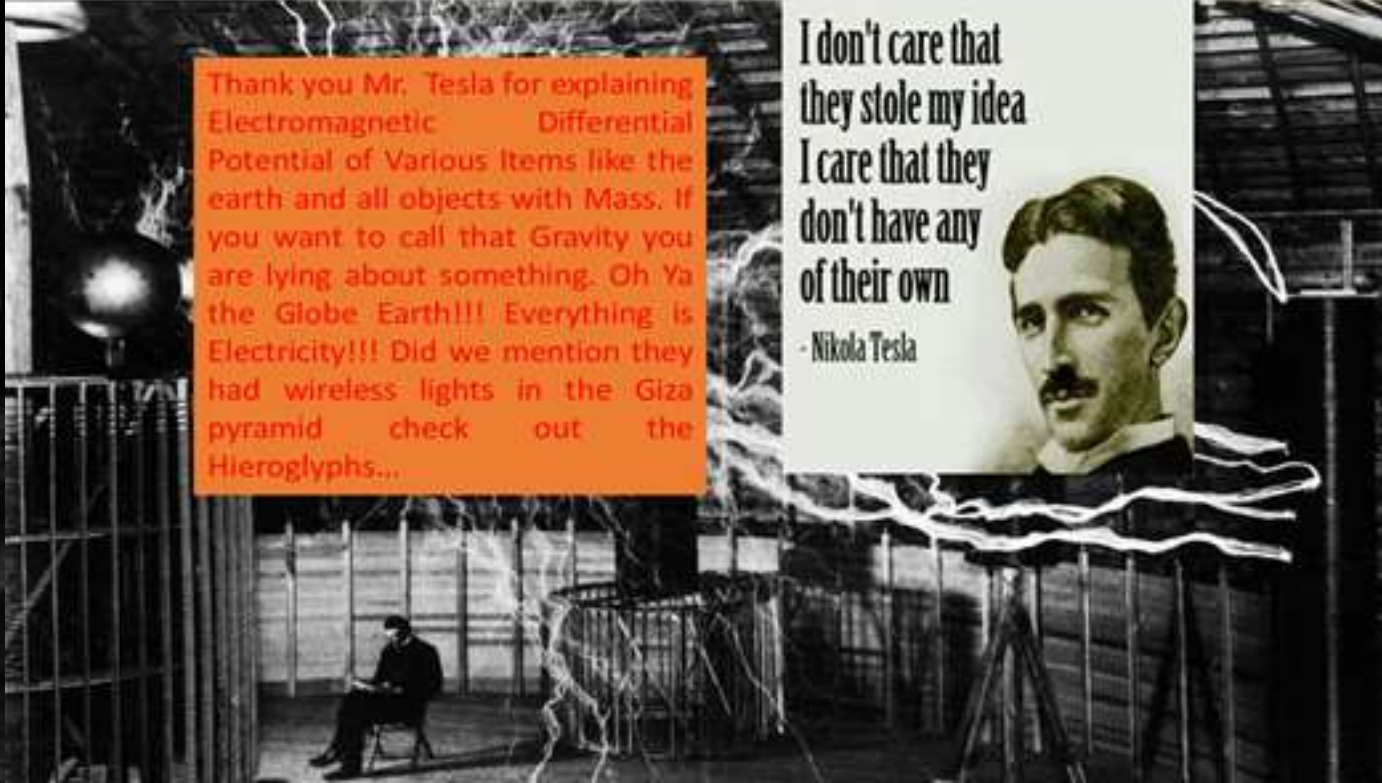

Why are the Illuminati and  
Masons and Jesuits giving  
you the Mocking Tongue???

Answer is they know what  
you don't... and they are  
blaming the coming of  
Christ on Climate Change  
and you are buying it!!!

# Conclusion





# 14 Year Last Days Timing 2010-2024



**July 26, 2018**  
The 9<sup>th</sup> Blood Moon of the 9<sup>th</sup> tetrad.  
**Speed of the Sun = 880 mph = BNM is Fortresses of Bastards Fall / Righteous Afflicted**

**Feb. 20, 2018**  
11<sup>th</sup> month 24<sup>th</sup> day  
Loosing of the 4 Carpenters to rebuild Jerusalem.  
**Speed of the Moon = 861 mph = BNM is Anti-Christ Comes**

**Sept. 27, 2024**  
Day of Atonement; Jesus and his great Multitude and the battle of Armageddon.  
**Speed of the Moon = 862mph = BNM is The Great Tribulation (End)**

**Oct. 3, 2024**  
Feast of tabernacles; Jesus fellowship with Men in Jerusalem.  
**Speed of the Sun = 1077 mph = BNM is Where O Death is Your Sting? / Fire from Heaven.**

**Sept. 15, 2024**  
feast of Trumpets  
Start of Jesus returning.  
**Speed of the Sun = 1025 mph = BNM is if you See an Angel Leave the City.**

**Jan. 31, 2018**  
the 8<sup>th</sup> Blood Moon of the 9<sup>th</sup> final and perfect tetrad.  
**Speed of the Sun = 1175 mph = BNM is Trumpets Sound the End is Here.**

**Dec. 11, 2017**  
Two Witnesses Start 42 Months of ministry will finish on May 24/27, 2021.  
**Speed of the Sun = 1272 mph = BNM is Love Wisdome**

**Aug. 16, 2024**  
Dan 9:24-27 1260 days complete.  
**Speed of the Sun = 940 mph = BNM is Cities that Spurn the Prophet Go to Hell.**

**Feb. 4, 2023**  
Antichrist is Thrown in the Lake of Fire after 1260 days reigning  
**Speed of the sun is 1162.6 mph and 1011 NMPH. BNM=1163=SPIRIT OF ANTICHRIST IN THE WORLD**

**Nov. 9, 2017**  
Trump starts his 378 days in Noah's Timeframe and **Nov. 16** day of Alice in Wonderland tweet. He will come out on Nov.22,2018. **Speed of the Sun = 1184 mph = BNM is Beast of the Earth Eats the Flesh of his Harlot / The Beast**

**Dec. 6, 2017**  
Leeland Teaches Cyrus Decree fulfilled by Trump Embassy Move of USA to Jerusalem.  
**Speed of the Sun = 1258 mph = BNM is Depart Love of the Lord: Dead on Arrival.**

**Nov. 11, 2021**  
Abom. That Makes Desolate. The Sophia Robot that talks is setup on the temple (Dan.12:11)  
**Speed of the sun = 1187 mph = BNM is Satan Chained: Millennium Kingdom of God / City Burns New Covenant**

**March 5, 2021**  
End of the trumpets and the start of the Bowls. **Speed of the Sun = 1180 mph = BNM is Killed by the Sword, Taken Captive by the Beast / High Priest Abandons the Flock.**

**Sept. 23, 2015**  
Pope Francis False Prophet appears in America.  
**Speed of the Sun in Nautical Miles is 911nmph. BNM is Man's Glory is Nothing / Man's Leadership**

**Sept. 22-23, 2017** - Sun Clad Woman sign 9-22 Start of Tribulation .  
**Speed of the Sun 911 nmph = BNM is Man's Glory is Nothing / Man's Leadership**

**Mar. 13, 2019**  
End of Loosing of the 4 Carpenters.  
**Speed of the Sun = 1155 mph = BNM is Rejoice: You Participate in Sufferings of Christ /**

**Aug. 24, 2019**  
The Antichrist and Latter Rain and WW3 Starts his Reign  
**Speed of the Sun = 962 mph = Height of Ciza since 28 BNM SERVANTS OF SATAN IN GREAT FEAR BEFORE GOD. Angle of Sun = 49= BNM= time of end.**

**Aug. 20, 2017**  
Great American Eclipse is Leeland's timing of the end of the 1<sup>st</sup> 7 years of Ahasuerus. Start of Bad years. **Speed of the Moon = 809 mph = BNM is Table of Money-lenders Over-turned.**

**July 25, 2015**  
Baphomet is in Detroit symbolizes the Obama. Dan. 7:8 Little Horn birth  
**Speed of the Sun = 877 mph = BNM is Man's Possessions Devoured.**

**Sept. 11, 2001**  
The Beginning of the Great Falling Away i.e. 2 Thess. 2:3 or Isa 9:10,11  
**Speed of the Moon = 1039nmph = BNM is The Great Falling Away**

**Jan. 21, 2019**  
Final Blood Moon and end Joseph Good years. **Speed of the moon = 1020 mph = BNM is Testimony of Jesus Gathers the Believers / Holy Communion.**

**April 30, 2018**  
Date Leeland says the Daily Sacrifice is taken Away.  
**Speed of the sun in nautical miles = 801 nmph = BNM is Without God Holy Angels Fall Down**

**Nov. 22, 2018**  
Trump's Noah timeframe end he comes out of the Boat. **Speed of the moon = 1037 mph = BNM is Duped Disciples Hear Truth of Jesus / King of Jews: Messiah.**

Joseph 7 Good Years  
Joseph 7 Bad Years

Trumpets

Bowls

Jesus Return / Armageddon

Trumpets

Trumpets

Beginning of Sorrows



Luke 8:17 For nothing is secret, that shall not be made manifest; neither any thing hid, that shall not be known and come abroad.

# Enoch's Last Days Calendar rediscovered in Qumran in John the Baptist /Essene Caves in 1947 by a Bedouin Shepard

## CREATION CALENDAR

4 <sup>th</sup> Gate 7-Nisan		5 <sup>th</sup> Gate 8-Iyyar		6 <sup>th</sup> Gate 9-Sivan		6 <sup>th</sup> Gate 10-Tammuz		5 <sup>th</sup> Gate 11-Av		4 <sup>th</sup> Gate 12-Elu		3 <sup>rd</sup> Gate 1-Tishrei		2 <sup>nd</sup> Gate 2-Cheshvan		1 <sup>st</sup> Gate 3-Kislev		1 <sup>st</sup> Gate 4-Tevet		2 <sup>nd</sup> Gate 5-Shevat		3 <sup>rd</sup> Gate 6-Adar			
3/21		4/20		5/20		6/20		7/20		8/19		Yom Teruah 9/19		10/19		11/18		12/19		1/18		2/17			
YOM		YOM		YOM		YOM		YOM		YOM		YOM		YOM		YOM		YOM		YOM		YOM		YOM	
2	22	2 Shab	21	2	21	2	21	2 Shab	21	2	20	2	20	2 Shab	20	2	19	2	20	2 Shab	19	2	18		
3	23	3	22	3	22	3	22	3 Wine	22	3	21	3	21	3	21	3	20	3	21	3	20	3	19		
4 Shab	24	4	23	4	23	4 Shab	23	4	23	4	22	4 Shab	22	4	22	4	21	4 Shab	22	4	21	4	20		
5	25	5	24	5	24	5	24	5	24	5	23	5	23	5	23	5	22	5	23	5	22	5	21		
6	26	6	25	6	25	6	25	6	25	6	24	6	24	6	24	6	23	6	24	6	23	6	22		
7	27	7	26	7 Shab	26	7	26	7	26	7 Shab	25	7	25	7	25	7 Shab	24	7	25	7	24	7 Shab	23		
8	28	8	27	8	27	8	27	8	27	8	26	8	26	8	26	8	25	8	26	8	25	8	24		
9	29	9 Shab	28	9	28	9	28	9 Shab	28	9	27	9Atone	27	9 Shab	27	9	26	9	27	9	27	9 Shab	26		
10	30	10	29	10	29	10	29	10	29	10	28	10	28	10	28	10	27	10	28	10	27	10	26		
11Shab	31	11	30	11	30	11Shab	30	11	30	11	29	11Shab	29	11	29	11	28	11Shab	29	11	28	11	27		
12	Apr	12	May	12	31	12	Jul	12	31	12	30	12	30	12	30	12	29	12	30	12	29	12	28		
13	2	13	2	13	Jun	13	2	13	Aug	13	31	13	31	13	31	13	30	13	31	13	30	13	Mar		
14 Pas	3	14	3	14Shab	2	14	3	14	2	14Shab	Sep	14	2	14	Nov	14Shab	Dec	14	Jan	14	31	14Shab	2		
15 ULB	4	15	4	15Shab	3	15	4	15	3	15	2	15 Sub	3	15	2	15	2	15	2	15	2	15	3		
16	5	16Shab	5	16	4	16	5	16Shab	4	16	3	16	4	16Shab	3	16	3	16	3	16	3	16Shab	4		
17	6	17	6	17	5	17	6	17	5	17	4	17	5	17	4	17	4	17	4	17	4	17	5		
18Shab	7	18	7	18	6	18Shab	7	18	6	18	5	18Shab	6	18	5	18	5	18	5	18	5	18	6		
19	8	19	8	19	7	19	8	19	7	19	6	19	7	19	6	19	6	19	6	19	6	19	7		
20	9	20	9	20	8	20	9	20	8	20	7	20	8	20	7	20	7	20	7	20	7	20	8		
21	10	21	10	21Shab	9	21	10	21	9	21Shab	8	21	9	21	8	21Shab	8	21	8	21	7	21Shab	9		
22	11	22	11	22	10	22	11	22	10	22	9	22	10	22	9	22	9	22	9	22	9	22	10		
23	12	23Shab	12	23	11	23	12	23Shab	11	23	10	23	11	23Shab	10	23	10	23	10	23	10	23Shab	11		
24	13	24	13	24	12	24	13	24	12	24	11	24	12	24	11	24	11	24	11	24	11	24	12		
25Shab	14	25	14	25	13	25Shab	14	25	13	25	12	25Shab	13	25	12	25	12	25	12	25	12	25	13		
26 F.F.	15	26	15	26	14	26	15	26	14	26	13	26	14	26	13	26	13	26	13	26	13	26	14		
27	16	27	16	27	15	27	16	27	15	27	14	27	15	27	14	27	14	27	14	27	14	27	15		
28	17	28	17	28Shab	16	28	17	28	16	28Shab	15	28	16	28	15	28Shab	15	28	15	28	15	28	16		
29	18	29	18	29	17	29	18	29	17	29	16	29	17	29	16	29	16	29	16	29	16	29	17		
30	19	30Shab	19	30	18	30	19	30Shab	18	30	17	30	18	30Shab	17	30	17	30	17	30	17	30	18		
				31	19					31	18					31	18					31	19		

Three Principle Gates  
Enoch 75:6-8

Season Leader  
Jun 19  
Hot Winds

Season Leader  
Sep 18  
Grateful  
odour, dew,  
rain, health,  
and life

Season Leader  
Dec 18  
Dew, rain,  
blight, and  
destruction

71:9 In the same  
manner it goes  
forth in the first  
month by the  
GREAT GATE.

THE GREAT  
GATE  
SHUVAH  
HA'SHANAH  
March 20



Luke 8:17 For nothing is secret, that shall not be made manifest; neither any thing hid, that shall not be known and come abroad.

# I'am I'am and the deceiver is NOT I'AM

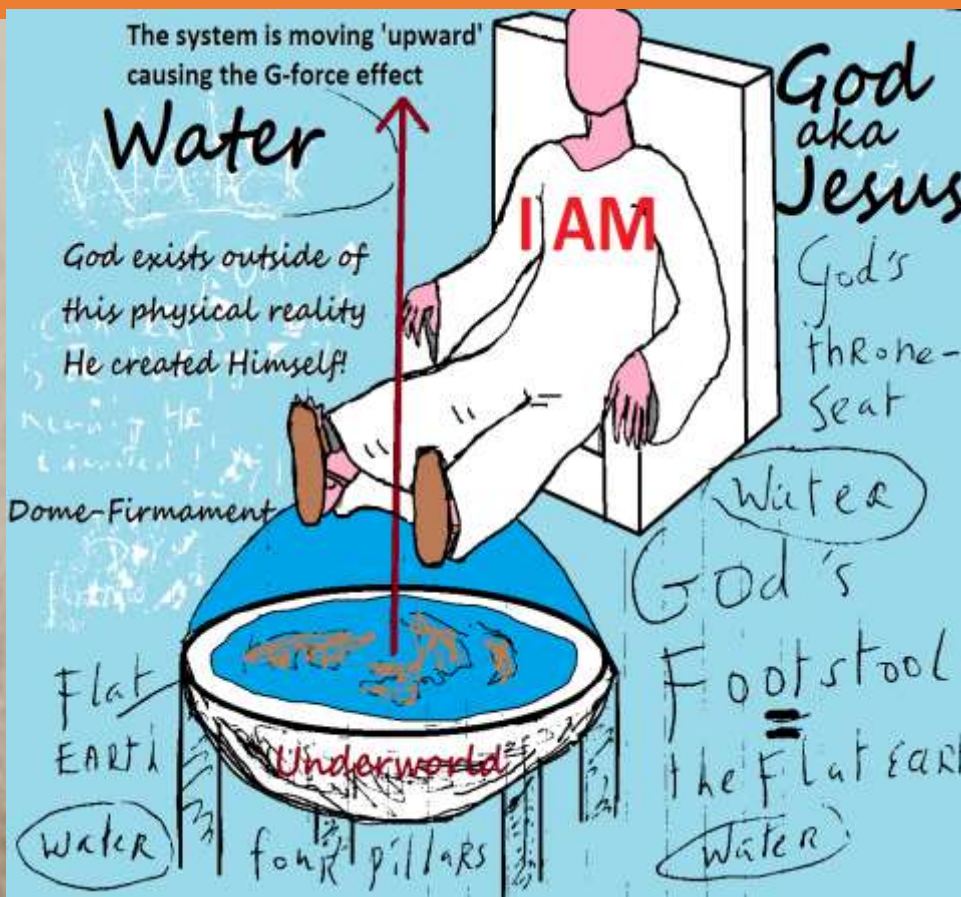

## THE BLACK CUBE OF SATURN



AUSTRALIA



DENMARK



MANHATTAN



SANTA ANA





Luke 8:17 For nothing is secret, that shall not be made manifest; neither any thing hid, that shall not be known and come abroad.

During the Loosing of the 4 Carpenters (God is killing off some of his most ardent enemies!!!)

**"It's easier to fool people than to convince them they have been fooled"**

**-Mark Twain**

Mark Twain a mason, speaks the truth. It is easier to fool the people than convince them they have been fooled!!!





**God's Flat Earth: Everything Comes from Giza Gods witness and testimony. Isa 19,20**

**Great White throne of Judgment=Rev. 20:11**

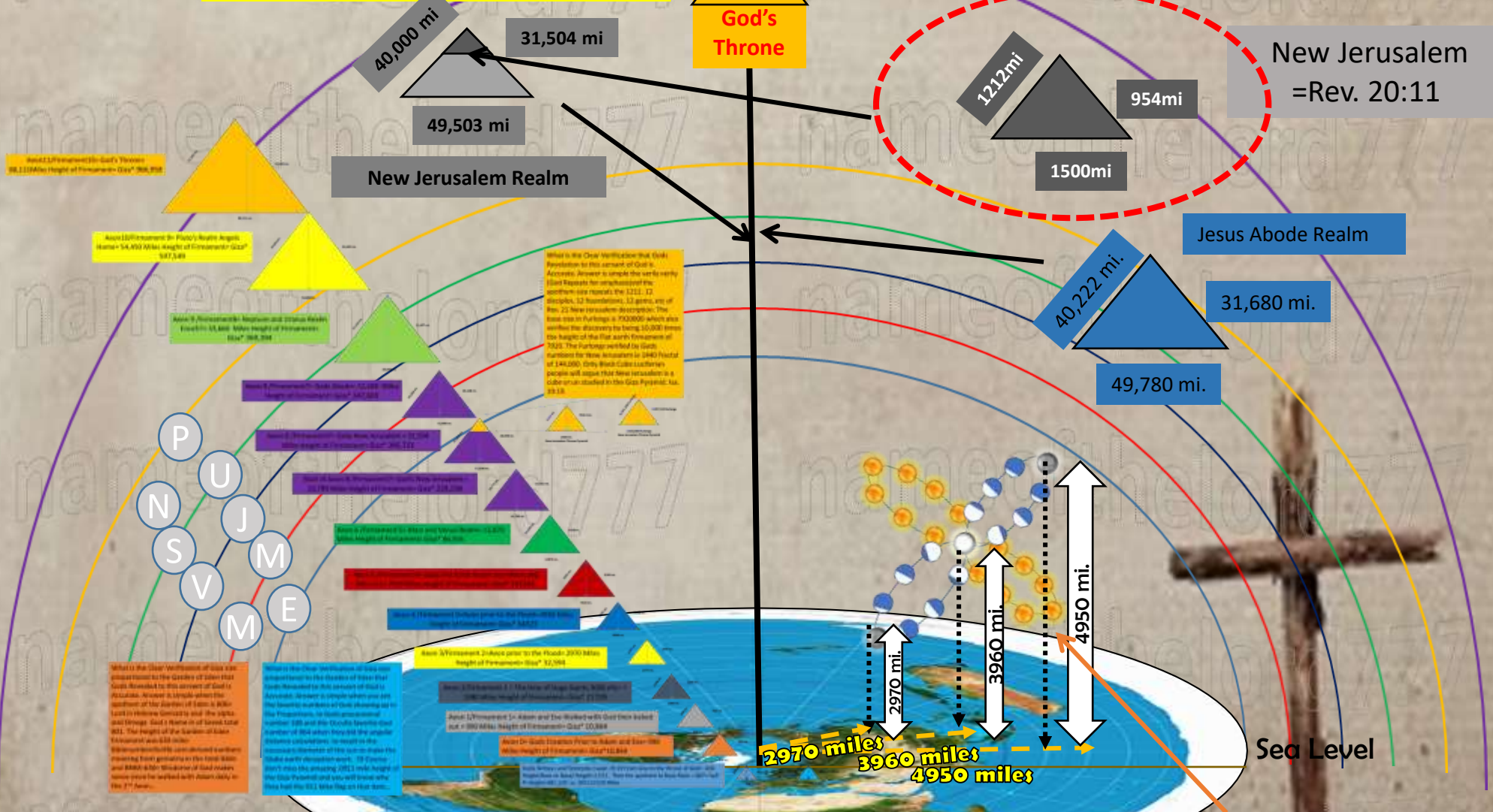

Teaching the keys to the heights and distances of the Sun and the Moon from Sea Level and the North Pole.



God's Throne = 88022 mi. above the NP = Great White Throne of Judgment Rev. 20:11

Jesus Abode = 31,680 mi.

New Jerusalem = 31,504 mi. = Rev. 21:2

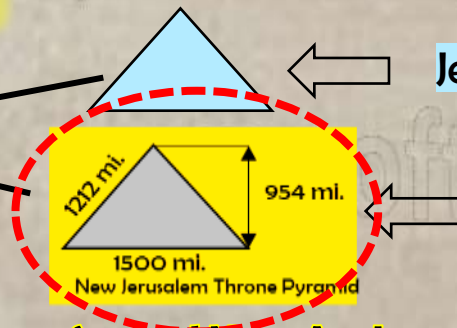

Sun and Moon Analemma = Aleph and Tav = Name of the Lord

Sun and Moon Horizontal Speeds moving in the firmament

- ☐ 778 mph at the Tropic of Cancer (BNM=Good News)
- ☐ 1037 mph at the Equator (BNM=Falling Away)
- ☐ 1296 mph at the Tropic of Capricorn (BNM= New Jerusalem)

10<sup>th</sup> Firmament = God's Throne = 88,022 mi. (88022 Trump text)

9<sup>th</sup> = 54,450 mi. Pluto & Angels

8<sup>th</sup> = 33,660 mi. Neptune & Uranus

7<sup>th</sup> = 20,790 mi. Saturn & Jupiter Jesus & NJ

6<sup>th</sup> = 12,870 mi. Venus & Mars

5<sup>th</sup> = 7920 mi. Mercury & Earth

2970 miles

3960 miles

4950 miles

Sea Level

When Traveling the Firmament, the Sun with a complete cycle = 365.24 days changes 10.84 miles in elevation as it travel a Fibonacci curve crisscrossing the Moon down the firmament. The Moon creating the 14 phases changes elevation and increases by 67.05 miles a day with a complete cycle = 59.06 days. Daily snapshots from the same spot will create the Analemma. For More Details go to [flatearhandthelastdaysblog.wordpress.com](http://flatearhandthelastdaysblog.wordpress.com)



## **Thank You God the Father and the Son and the Holy Ghost**

**The Others that came before us are the true Giants we're just Blessed to come along at the right time in History for Jesus to take us from despair and Mold us in clay to a vessel humble enough to serve Him unto Death!!! Anthony Scalia gave his Life Most recently and David Flynn, JFK, Abe Lincoln, William Tyndale and Anne Frank all gave their lives to Do Gods will of fighting the Mason's and their Ashkenazi Jewish, Demon, Cohorts. However, God has a place in eternity and I look forward to our time there. Our work has been tireless most nights 4 hours sleep and 6 days a week for 10-12 hours a day for three and half years now. Just like Jesus Ministry I feel we have done our work I pray you will welcome us with the" Good and faithful Servant Greeting..." You took such a broken individual considered foolish by family and friends and have used me to confound those calling themselves wise and yet they are deceivers to the world...thank you for your love Letter, the Bible... Love Mark**



Luke 8:17 For nothing is secret, that shall not be made manifest; neither any thing hid, that shall not be known and come abroad.

Leeland's' Last Day timing with Sun and Moon speeds added for emphasis

THANKS  
FOR WATCHING!



JESUS IS COMING SOON!

